

# **7706LR Series**

## **7706LR L-Band Fiber Receiver**

### **User Manual**

© Copyright 2013 - 2016

**EVERTZ MICROSYSTEMS LTD.**

5288 John Lucas Drive  
Burlington, Ontario  
Canada L7L 5Z9

Phone: 905-335-3700  
Sales: sales@evertz.com Fax: 905-335-3573  
Tech Support: service@evertz.com Fax: 905-335-7571  
Web Page: <http://www.evertz.com>



Version 1.1, November 2016

The material contained in this manual consists of information that is the property of Evertz Microsystems and is intended solely for the use of purchasers of the 7706LR series product. Evertz Microsystems expressly prohibits the use of this manual for any purpose other than the operation of the 7706LR series product. Due to on going research and development, features and specifications in this manual are subject to change without notice.

All rights reserved. No part of this publication may be reproduced without the express written permission of Evertz Microsystems Ltd. Copies of this manual can be ordered from your Evertz dealer or from Evertz Microsystems.

*This page left intentionally blank*

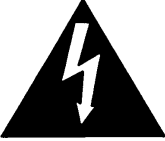
## IMPORTANT SAFETY INSTRUCTIONS

	The lightning flash with arrowhead symbol within an equilateral triangle is intended to alert the user to the presence of uninsulated “Dangerous voltage” within the product’s enclosure that may be of sufficient magnitude to constitute a risk of electric shock to persons.
	The exclamation point within an equilateral triangle is intended to alert the user to the presence of important operating and maintenance (Servicing) instructions in the literature accompanying the product.

- Read these instructions
- Keep these instructions.
- Heed all warnings.
- Follow all instructions.
- Do not use this apparatus near water
- Clean only with dry cloth.
- Do not block any ventilation openings. Install in accordance with the manufacturer’s instructions.
- Do not install near any heat sources such as radiators, heat registers, stoves, or other apparatus (including amplifiers) that produce heat.
- Do not defeat the safety purpose of the polarized or grounding-type plug. A polarized plug has two blades with one wider than other. A grounding-type plug has two blades and a third grounding prong. The wide blade or the third prong is provided for your safety. If the provided plug does not fit into your outlet, consult an electrician for replacement of the obsolete outlet.
- Protect the power cord from being walked on or pinched particularly at plugs, convenience receptacles and the point where they exit from the apparatus.
- Only use attachments/accessories specified by the manufacturer
- Unplug this apparatus during lightning storms or when unused for long periods of time.
- Refer all servicing to qualified service personnel. Servicing is required when the apparatus has been damaged in any way, such as power-supply cord or plug is damaged, liquid has been spilled or objects have fallen into the apparatus, the apparatus has been exposed to rain or moisture, does not operate normally, or has been dropped.

### **WARNING**

TO REDUCE THE RISK OF FIRE OR ELECTRIC – SHOCK, DO NOT EXPOSE THIS APPARATUS TO RAIN OR MOISTURE

### **WARNING**

DO NOT EXPOSE THIS EQUIPMENT TO DRIPPING OR SPLASHING AND ENSURE THAT NO OBJECTS FILLED WITH LIQUIDS ARE PLACED ON THE EQUIPMENT

### **WARNING**

TO COMPLETELY DISCONNECT THIS EQUIPMENT FROM THE AC MAINS, DISCONNECT THE POWER SUPPLY CORD PLUG FROM THE AC RECEPTACLE

### **WARNING**

THE MAINS PLUG OF THE POWER SUPPLY CORD SHALL REMAIN READILY OPERABLE

# INFORMATION TO USERS IN EUROPE

## NOTE

### CISPR 22 CLASS A DIGITAL DEVICE OR PERIPHERAL

This equipment has been tested and found to comply with the limits for a Class A digital device, pursuant to the European Union EMC directive. These limits are designed to provide reasonable protection against harmful interference when the equipment is operated in a commercial environment. This equipment generates, uses, and can radiate radio frequency energy and, if not installed and used in accordance with the instruction manual, may cause harmful interference to radio communications. Operation of this equipment in a residential area is likely to cause harmful interference in which case the user will be required to correct the interference at his own expense.

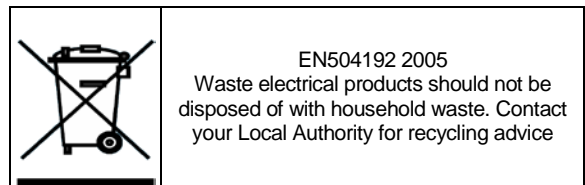
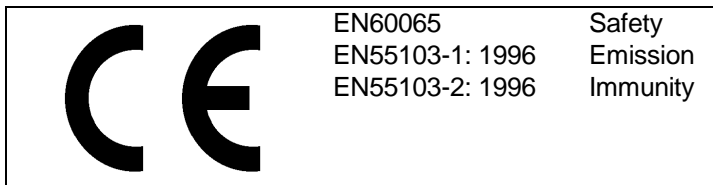

# INFORMATION TO USERS IN THE U.S.A.

## NOTE

### FCC CLASS A DIGITAL DEVICE OR PERIPHERAL

This equipment has been tested and found to comply with the limits for a Class A digital device, pursuant to Part 15 of the FCC Rules. These limits are designed to provide reasonable protection against harmful interference when the equipment is operated in a commercial environment. This equipment generates, uses, and can radiate radio frequency energy and, if not installed and used in accordance with the instruction manual, may cause harmful interference to radio communications. Operation of this equipment in a residential area is likely to cause harmful interference in which case the user will be required to correct the interference at his own expense.

## WARNING

Changes or Modifications not expressly approved by Evertz Microsystems Ltd. could void the user's authority to operate the equipment.

Use of unshielded plugs or cables may cause radiation interference. Properly shielded interface cables with the shield connected to the chassis ground of the device must be used.

## TABLE OF CONTENTS

1.	OVERVIEW .....	1
2.	INSTALLATION.....	3
2.1.	7706LR CONNECTIONS .....	4
2.2.	CARE AND HANDLING OF OPTICAL FIBER.....	4
2.2.1.	Handling and Connecting Fibers.....	4
3.	7706LR SPECIFICATIONS .....	5
3.1.	RF OUTPUTS .....	5
3.2.	OPTICAL INPUT.....	5
3.3.	ELECTRICAL .....	5
3.4.	PHYSICAL.....	5
4.	STATUS INDICATORS AND DISPLAYS .....	7
4.1.	7706LR STATUS INDICATORS .....	7
5.	JUMPER POSITIONS.....	9
5.1.	7706LR JUMPERS .....	9
5.2.	SELECTING WHETHER LOCAL FAULTS WILL BE MONITORED BY THE GLOBAL FRAME STATUS.....	9
5.3.	CONFIGURING THE MODULE FOR FIRMWARE UPGRADES.....	10
5.4.	FACTORY AND BDM JUMPERS .....	10
5.5.	7706LR PARAMETERS.....	12
5.5.1.	Selecting the Output Gain Mode .....	12
5.5.2.	Enabling/Disabling Squelch Mode .....	12
5.5.3.	Adjusting the RF Output Manual Gain.....	12
5.5.4.	Adjusting the AGC Target Level.....	13

**Figures**

Figure 1-1: 7706LR Block Diagram .....	1
Figure 2-1: 7706LR Rear Panel .....	3
Figure 5-1: Location of 7706LR Jumpers and LEDs .....	9

**Tables**

Table 4-1: LED Status Indicators .....	8
Table 5-1: Dip Switches.....	11

## REVISION HISTORY

<u>REVISION</u>	<u>DESCRIPTION</u>	<u>DATE</u>
1.0	First Release	Mar 2013
1.1	SMA Connector added to Specifications section	Nov 2016

Information contained in this manual is believed to be accurate and reliable. However, Evertz assumes no responsibility for the use thereof nor for the rights of third parties, which may be affected in any way by the use thereof. Any representations in this document concerning performance of Evertz products are for informational use only and are not warranties of future performance, either expressed or implied. The only warranty offered by Evertz in relation to this product is the Evertz standard limited warranty, stated in the sales contract or order confirmation form.

Although every attempt has been made to accurately describe the features, installation and operation of this product in this manual, no warranty is granted nor liability assumed in relation to any errors or omissions unless specifically undertaken in the Evertz sales contract or order confirmation. Information contained in this manual is periodically updated and changes will be incorporated into subsequent editions. If you encounter an error, please notify Evertz Customer Service department. Evertz reserves the right, without notice or liability, to make changes in equipment design or specifications.

## WARNING

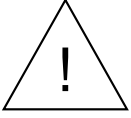

***Do not*** connect the 7706LR without optical attenuation to a transmitter producing in excess of +3dBm optical power. Maximum optical input to the 7706LR is +3dBm – more power than this may damage the receiver.



## 1. OVERVIEW

The 7706LR is a fiber optic receiver for receiving extended L-Band and other signals. It accepts a fiber optic input from a companion transmitter and provides an electrical output signal. Control of the card is provided locally at the card edge via DIP Switches.

The 7706LR occupies one card slot and can be housed in a 1RU frame that will hold up to four modules, a 3RU frame that will hold up to 15 modules, a 350FR portable frame that will hold up to seven modules or a standalone enclosure, which holds one module.

### Features:

- Protocol transparent - receives all video, audio and data modulation formats
- Supports manual and automatic (AGC) gain control modes
- Two buffered RF outputs for extra signal distribution or monitoring functions
- RF output independent of optical loss (within AGC range)
- Available with BNC or F-Type connector options
- Wide range optical input (1270nm to 1610nm)
- Supports single-mode and multi-mode fiber optic cable
- Available with SC/UPC, ST/UPC, FC/UPC, SC/APC and FC/APC connector options
- Fully hot-swappable from front of frame

### Ordering Information:

- **7706LR** Wideband RF Fiber Receiver
- **7706LR-B50** Wideband RF Fiber Receiver, 50Ω BNC connectors
- **7706LR-S50** Wideband RF Fiber Receiver, 50Ω SMA connectors

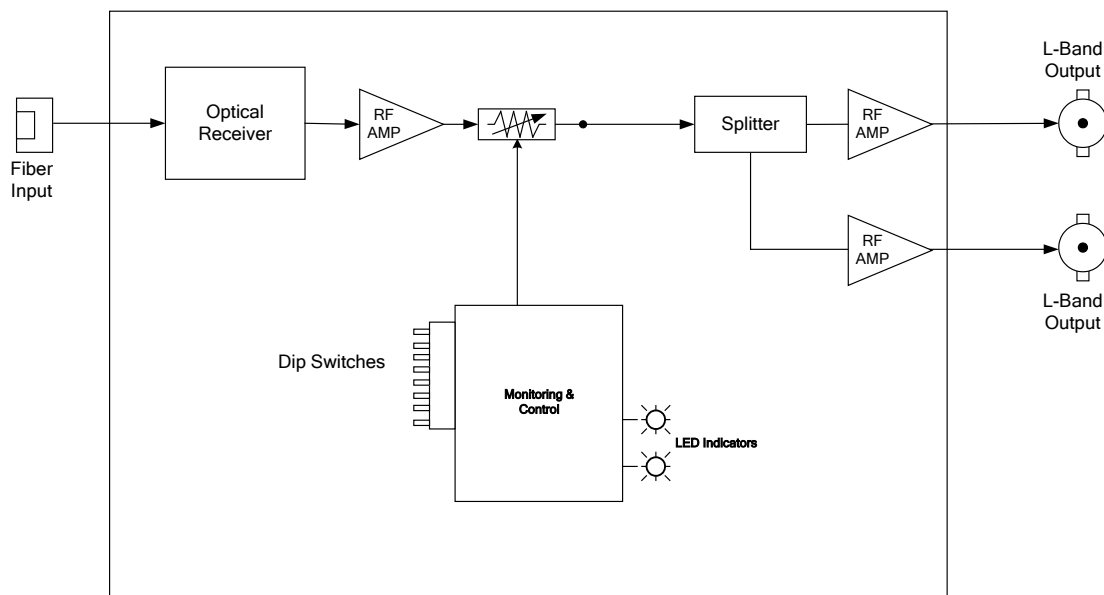

**Figure 1-1: 7706LR Block Diagram**

*This page left intentionally blank*

## 2. INSTALLATION

The 7706LR comes with a companion rear plate appropriate for a 1RU, 3RU or standalone enclosure as specified at the time of order. SC/UPC, SC/APC, ST/UPC, FC/UPC or FC/APC optical connectors are available and the type specified at the time of order will be installed. For information on mounting the rear plate and inserting the module into the frame, see the 7700FR manual for detailed instructions.

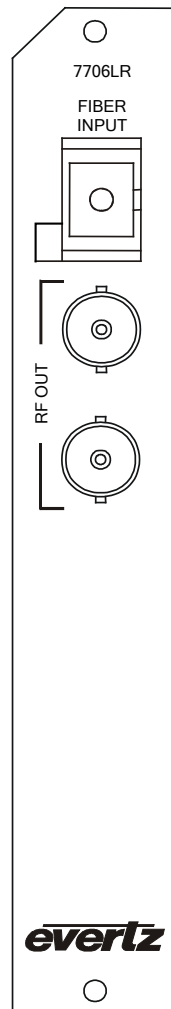

Figure 2-1: 7706LR Rear Panel

## 2.1. 7706LR CONNECTIONS

**FIBER INPUT:** SC/UPC, SC/APC, ST/UPC, FC/UPC or FC/APC female connector. This connector should be connected with a suitable fiber optic cable to the optical output of an appropriate transmitter at the origin. The standard connector type is UPC. This connector type is compatible with standard PC connectors, but for optimal return loss performance, Evertz recommends the use of UPC fiber terminations throughout the system. The optional APC connectors provide further enhanced return loss performance, and when specified, should also be used throughout the system.

**L-BAND OUT:** Two electrical output connectors for the received L-band signals. The dual connectors provide an extra connector for monitoring or further distribution.



**Unused connectors should be terminated with appropriate loading (50 or 75 Ohm).**

## 2.2. CARE AND HANDLING OF OPTICAL FIBER

### 2.2.1. Handling and Connecting Fibers



**Never touch the end face of an optical fiber. Always keep dust caps on optical fiber connectors when not connected and always remember to properly clean the optical end facet of a connector before making a connection.**

The transmission characteristics of the fiber are dependent on the shape of the optical core and therefore care must be taken to prevent fiber damage due to heavy objects or abrupt fiber bending. Evertz recommends that you maintain a minimum bending radius of 5 cm to avoid fiber-bending loss that will decrease the maximum attainable distance of the fiber cable. Evertz fiber optic modules come with cable lockout devices to prevent the user from damaging the fiber by installing a module into a slot in the frame that does not have a suitable rear plate installed.

### 3. 7706LR SPECIFICATIONS

#### 3.1. RF OUTPUTS

<b>Number of Outputs:</b>	2
<b>Connector:</b>	BNC per IEC 61169-8 Annex A, F type and SMA optional
<b>I/O Impedance:</b>	75 $\Omega$ (50 $\Omega$ optional)
<b>Return Loss:</b>	>15dB
<b>Frequency Range:</b>	120MHz-2250MHz
<b>Output IP3:</b>	+28dBm
<b>Output Signal Level:</b>	
<b>Manual Gain:</b>	-10 to-65dBm (depending on input signal level, gain setting and optical loss)
<b>AGC Mode:</b>	-20dBm



See System Performance Specifications of the chosen companion transmitter for more details.

#### 3.2. OPTICAL INPUT

<b>Number of inputs:</b>	1
<b>Connector:</b>	Female SC/UPC, SC/APC, ST/UPC, FC/UPC, FC/APC
<b>Operating Wavelength:</b>	1270nm - 1610nm
<b>Max Input Power:</b>	+3dBm
<b>Optical Sensitivity:</b>	-14dBm at 35dB S/N on a 36MHz carrier

#### 3.3. ELECTRICAL

<b>Voltage:</b>	+12VDC
<b>Power:</b>	6 Watts
<b>EMI/RFI:</b>	Complies with FCC Part 15, class A Complies with EU EMC directive

#### 3.4. PHYSICAL

<b>350FR:</b>	1
<b>7700FR-C:</b>	1
<b>7800FR:</b>	1

*This page left intentionally blank*

## 4. STATUS INDICATORS AND DISPLAYS

### 4.1. 7706LR STATUS INDICATORS

The 7706LR has nine LED status indicators on the front card edge to show operational status of the card at a glance. See Figure 5-1 for LED locations.

Two large LEDs on the front of the board indicate the general health of the module:

**LOCAL FAULT:** This red LED indicates poor module health and will be on during the absence of a valid optical input signal or if a local internal power fault exists (i.e.: a blown fuse). Whether or not this LOCAL FAULT indication is reported to the frame may be selected by the FRAME STATUS jumper (see section 5.1).

**MODULE OK:** This green LED indicates good module health. It will be on when a valid optical input signal is present, and the board power is good.

There are 7 small LEDs that indicate the status of the output RF signal, and optical input signal.

**RF HIGH:** This red LED will be on when the output RF signal is higher than the RF high threshold setting.

**RF OK:** This green LED will be on when the output RF signal is within threshold settings.

**RF LOW:** This yellow LED will be on when the output RF signal is lower than the RF low threshold setting.

**OPTICAL INPUT HIGH:** This red LED will be on when the input optical power is higher than the optical power high threshold setting.

**OPTICAL INPUT OK:** This green LED will be on when the input optical power is within threshold settings.

**OPTICAL INPUT LOW:** This yellow LED will be on when the optical power is lower than the optical power low threshold setting.

**GAIN MODE:** This LED is on when AGC is enabled and off when Manual mode is enabled. It will be green when power levels are within the AGC hold range and a constant RF output level is being maintained. It will be red if power levels are either above or below the power levels required for the AGC circuit to be able to maintain a constant level.

**SQUELCH MODE:** This LED is on when squelch is enabled. It will be green when squelch is enabled but not active. It will be red when squelch mode is enabled and the output signal is squelched.

LED #	Colour	Function
Local/ Fault	RED GREEN	
1	RED OFF	RF Output Power HIGH: > -5dBm RF Output Power not HIGH: <=-5dBm
2	GREEN OFF	RF Output Power OK: -5 dBm >= RF Output Power >= -50 dBm RF Output Power not OK: -5dBm < RF Output Power < -50dBm
3	YELLOW OFF	RF Output Power LOW: <-50 dBm RF Output Power not LOW: >=-50
4	RED OFF	Optical Input Power HIGH: >+5dBm Optical Input Power not HIGH: <=+3dBm
5	GREEN OFF	Optical Input Power OK: +5dBm >= Optical Input Power >= -14 dBm Optical Input Power not OK: +5 dBm < Optical Input Power < -14 dBm
6	YELLOW OFF	Optical Input Power LOW: <-14dBm Optical Input Power not LOW: >= -14dBm
7	RED GREEN OFF	AGC on but outside hold range AGC on and within hold range AGC off (manual mode)
8	RED GREEN OFF	Squelch enabled and active (<-50 dBm RF out) Squelch enabled and not active Squelch disabled

Table 4-1: LED Status Indicators



**5. JUMPER POSITIONS**

**5.1. 7706LR JUMPERS**

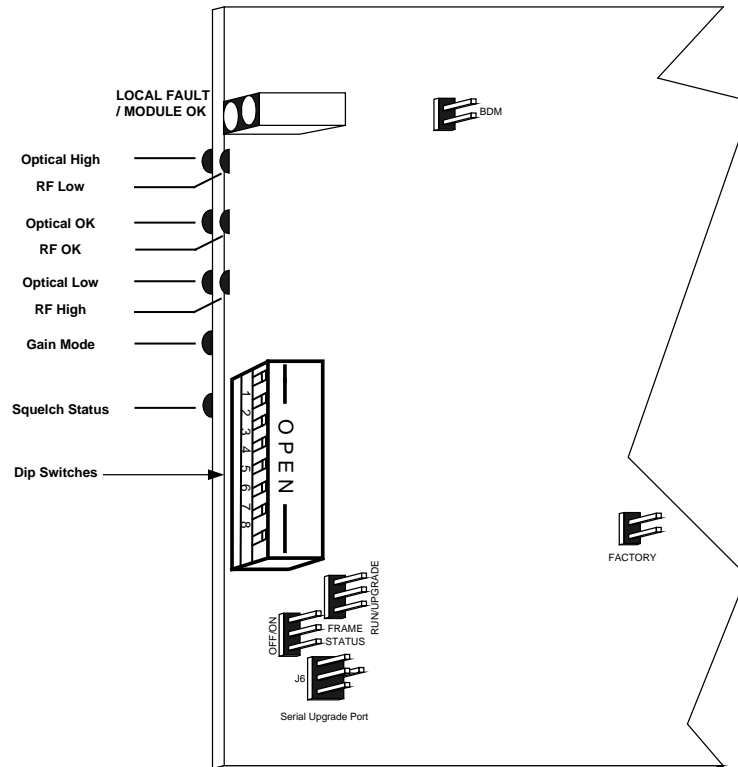

**Figure 5-1: Location of 7706LR Jumpers and LEDs**

**5.2. SELECTING WHETHER LOCAL FAULTS WILL BE MONITORED BY THE GLOBAL FRAME STATUS**

The FRAME STATUS jumper J3 determines whether local faults (as shown by the Local Fault indicator) will be connected to the 7700FR frame's global status bus.

**FRAME STATUS:** To monitor faults on this module with the frame status indicators (on the Power Supply FRAME STATUS LEDs and on the Frame's Fault Tally output) install this jumper in the ON position (default).

When this jumper is installed in the Off position local faults on this module will not be monitored.

### 5.3. CONFIGURING THE MODULE FOR FIRMWARE UPGRADES

**UPGRADE:** The UPGRADE jumper J5 is used when firmware upgrades are being done to the module. For normal operation it should be installed in the *RUN* position. See the *Upgrading Firmware* section of this manual for more information.

To upgrade the firmware:

1. Pull the module out of the frame.
2. Move the UPGRADE jumper into the *UPGRADE* position.
3. Install the Upgrade cable provided (located in the vinyl pouch in the front of this manual) onto the SERIAL header at the card edge.
4. Re-install the module into the frame.
5. Run the upgrade as described in the *Upgrading Firmware* section of this manual.
6. When the upgrade is completed, remove the module from the frame, move the UPGRADE jumper into the *RUN* position, remove the upgrade cable and re-install the module.

The module is now ready for normal operation.

### 5.4. FACTORY AND BDM JUMPERS

When shipped from the Evertz facility, the FACTORY and BDM jumpers will not be installed. These jumpers **should not** be installed for any reason. If jumpers are on these positions they should be removed.

Switch	Function	Notes
1	AGC	open = off, closed = on
2	Squelch	open = off, closed = on
3	not used	open = off, closed = on
4	manual gain / AGC target bit 1	open = off, closed = on
5	manual gain / AGC target bit 2	open = off, closed = on
6	manual gain / AGC target bit 3	open = off, closed = on
7	manual gain / AGC target bit 4	open = off, closed = on
8	manual gain / AGC target bit 5	open = off, closed = on

DIP 4,5,6,7,8 Setting	GAIN (dB)	AGC Target (dBm)
00000	-10	-35
00001	-8	-34
00010	-6	-33
00011	-4	-32
00100	-2	-31
00101	0	-30
00110	1	-29
00111	2	-28
01000	3	-27
01001	4	-26
01010	5	-25
01011	6	-24
01100	7	-23
01101	8	-22
01110	9	-21
01111	10	-20
10000	11	-19
10001	12	-18
10010	13	-17
10011	14	-16
10100	15	-15
10101	16	-14
10110	17	-13
10111	18	-12
11000	19	-11
11001	20	-10
11010	22	-9
11011	24	-8
11100	26	-7
11101	28	-6
11110	30	-5

Table 5-1: Dip Switches

**5.5. 7706LR PARAMETERS**

**5.5.1. Selecting the Output Gain Mode**

The 7706LR has two gain modes available:

**Manual** gain mode allows the user to select a fixed gain level for the RF signal.

**AGC** (automatic gain control) will maintain a constant output level even if the input RF level changes, as long as this input level does not go outside of the AGC hold range. The AGC target level is user adjustable.

To select the gain mode, use the Dip Switch 1.

<i>DIP SWITCH 1</i>		<b>AGC</b>	AGC mode
<i>MODE</i>		<b>MAN</b>	Manual mode
<i>ON</i>	<i>AGC</i>		
<i>OFF</i>	<i>MAN</i>		

**5.5.2. Enabling/Disabling Squelch Mode**

Squelch mode will turn off the RF output if it drops below -50dBm input RF power level. To enable or disable squelch mode, use Dip Switch 2.

<i>DIP SWITCH 2</i>		<b>EN</b>	Enable squelch mode
<i>SQL</i>		<b>DIS</b>	Disable squelch mode (default)
<i>ON</i>	<i>EN</i>		
<i>OFF</i>	<i>DIS</i>		

**5.5.3. Adjusting the RF Output Manual Gain**

The 7706LR can apply gain to adjust the level of the output signal. Gain may be applied when the card is set for manual mode. To set the gain, use the Dip Switches 4,5,6,7,8 according to the table (see Table 5-1).

<i>DIP SWITCH 4,5,6,7,8</i>		<b>-10 to +30 dBm</b>	Output signal gain level (default 0 dBm)
<i>GAIN</i>			
<i>See Table 5-1</i>			



**Note that this menu item is not applicable when in AGC mode.**

#### 5.5.4. Adjusting the AGC Target Level

The target output level to be maintained by the 7706LR when AGC mode is user adjustable. To set the AGC target level, use the Dip Switches 4,5,6,7,8 according to the table (see Table 5-1).

DIP SWITCH 4,5,6,7,8	-5 to -35 dBm      AGC output signal target level
AGC Target	
See Table 5-1	



**Note that this menu item is only applicable in AGC mode.**

*End of document*