

TABLE OF CONTENTS

1.	OVERVIEW	1
2.	INSTALLATION	3
2.1.	7807LR-2/7807LR-2-H CONNECTIONS	4
2.2.	CARE AND HANDLING OF OPTICAL FIBER	5
2.2.1.	Handling and Connecting Fibers.....	5
3.	7807LR-2/7807LR-2-H SPECIFICATIONS.....	6
3.1.	RF OUTPUTS.....	6
3.2.	OPTICAL INPUTS.....	6
3.3.	GENERAL PURPOSE OUTPUTS	6
3.4.	ELECTRICAL.....	6
3.5.	PHYSICAL.....	6
4.	STATUS INDICATORS AND DISPLAYS	7
4.1.	7807LR-2/7807LR-2-H STATUS INDICATORS	7
5.	JUMPER POSITIONS.....	8
5.1.	7807LR-2/7807LR-2-H JUMPERS AND LEDS	8
5.2.	SELECTING WHETHER LOCAL FAULTS WILL BE MONITORED BY THE GLOBAL FRAME STATUS.....	8
5.3.	CONFIGURING THE MODULE FOR FIRMWARE UPGRADES.....	9
5.4.	FACTORY AND BDM JUMPERS	9
5.5.	GPO JUMPERS	9
6.	DOT-MATRIX DISPLAY	10
6.1.	7807LR-2/7807LR-2-H CONTROLLED PARAMETERS	15
6.1.1.	Adjusting the Optical Power Alarm Thresholds.....	15
6.1.2.	Adjusting the RF Output Power Alarm and Squelch Thresholds.....	15
6.1.3.	Selecting the Output Gain Mode	16
6.1.4.	Adjusting the RF Output Gain	17

6.1.5.	Adjusting the AGC Target Level	17
6.1.6.	Enabling/Disabling Squelch Mode.....	18
6.1.7.	Setting the Card Edge Display Orientation.....	18
6.1.8.	Resetting Factory Defaults	18
6.2.	TRANSMITTER CONTROLLABLE PARAMETERS.....	18
6.2.1.	Adjusting the RF Input Power Alarm Thresholds	19
6.2.2.	Adjusting the Internal Transmitter Temperature Alarm Thresholds.....	19
6.2.3.	Adjusting the Input Voltage Alarm Thresholds.....	20
6.2.4.	Adjusting the LNB Current Alarm Thresholds	20
6.3.	7807LR-2/7807LR-2-H MONITORED CONDITIONS AND PARAMETERS	21
6.3.1.	Displaying the Input Optical Power.....	21
6.3.2.	Displaying the Output RF Power	21
6.3.3.	Displaying the Squelch Status.....	21
6.4.	TRANSMITTER MONITORED PARAMETERS.....	22
6.4.1.	Displaying the Presence of the Data Signal.....	22
6.4.2.	Displaying the Input RF Power to the Connected Transmitter.....	23
6.4.3.	Displaying the Gain Mode of the Connected Transmitter	23
6.4.4.	Displaying the Gain Level of the Connected Transmitter.....	23
6.4.5.	Displaying the AGC Status of the Connected Transmitter.....	24
6.4.6.	Displaying the RF Drive Status of the Connected Transmitter	24
6.4.7.	Displaying the Output Optical Power of the Connected Transmitter	24
6.4.8.	Displaying the Laser Status of the Connected Transmitter.....	25
6.4.9.	Displaying Status of the Power Supply Connected to the Transmitter	25
6.4.10.	Displaying the Internal Temperature of the Connected Transmitter	25
6.4.11.	Displaying the LNB Mode of the Connected Transmitter.....	26
6.4.12.	Displaying the LNB Voltage of the Connected Transmitter	26
6.4.13.	Displaying the LNB Current	26
6.4.14.	Displaying the Firmware Version of the Connected Transmitter	27
6.4.15.	Displaying the Model of the Connected Transmitter	27
7.	VISTALINK® REMOTE MONITORING/CONTROL	28
7.1.	WHAT IS VISTALINK®?.....	28
7.1.1.	VISTALINK® Monitored Parameters.....	29
7.1.2.	VISTALINK® Controlled Parameters	29
7.1.3.	VISTALINK® Traps	30

Figures

Figure 1-1: 7807LR-2/7807LR-2-H Block Diagram	2
Figure 2-1: 7807LR-2/7807LR-2-H Rear Panel	3
Figure 5-1: Location of 7807LR-2/7807LR-2-H Jumpers and LEDs	8
Figure 6-1: Card Edge Menu Structure	14

Tables

Table 7-1: VistaLINK [®] Monitored Parameters	29
Table 7-2: VistaLINK [®] Controlled Parameters	30
Table 7-3: VistaLINK [®] Traps	30

REVISION HISTORY

<u>REVISION</u>	<u>DESCRIPTION</u>	<u>DATE</u>
1.0	Initial Release	July 2011
1.1	Updated specifications, corrections	Sept 2011
1.2	Updated rear panel and block diagrams	June 2014

Information contained in this manual is believed to be accurate and reliable. However, Evertz assumes no responsibility for the use thereof nor for the rights of third parties, which may be affected in any way by the use thereof. Any representations in this document concerning performance of Evertz products are for informational use only and are not warranties of future performance, either expressed or implied. The only warranty offered by Evertz in relation to this product is the Evertz standard limited warranty, stated in the sales contract or order confirmation form.

Although every attempt has been made to accurately describe the features, installation and operation of this product in this manual, no warranty is granted nor liability assumed in relation to any errors or omissions unless specifically undertaken in the Evertz sales contract or order confirmation. Information contained in this manual is periodically updated and changes will be incorporated into subsequent editions. If you encounter an error, please notify Evertz Customer Service department. Evertz reserves the right, without notice or liability, to make changes in equipment design or specifications.

WARNING



Do not connect the 7807LR-2 without optical attenuation to a transmitter producing in excess of +3dBm optical power. Maximum optical input to the 7807LR-2 is +3dBm – more power than this may damage the receiver.



Do not connect the 7807LR-2-H without optical attenuation to a transmitter producing in excess of –7dBm optical power. Maximum optical input to the 7807LR-2-H is -7dBm – more power than this may damage the receiver.

This page left intentionally blank

1. OVERVIEW

The 7807LR-2 and 7807LR-2-H Fiber Optic Receivers are used for receiving RF signals transported optically over fiber optic cable by a companion transmitter. They accept two optical inputs and provide two pairs of electrical outputs. Individual monitoring and control is provided for each signal path. Gain may be adjusted manually in 0.5dB increments or managed automatically via AGC or IGC modes. SmartMON™ capability decodes and displays incoming information from the paired SmartMON™ enabled companion transmitter.

Two versions of the card are available, including the 7807LR-2 which has standard-sensitivity receivers, and the 7807LR-2-H which utilizes high-sensitivity receivers for medium/long-haul applications. With two optical receivers per single-slot card, the 7807LR-2 and 7807LR-2-H provide an economical and high density solution.

Features:

- Extended frequency response for extended L-Band off-air DTV and other signals
- Protocol independent design - transports all modulation formats
- Supports manual, automatic (AGC), and intelligent (IGC) gain control modes
- IGC mode provides simple automatic compensation for fiber loss while output level tracks LNB level input at SmartMON™ capable fiber transmitter
- 0.5dB gain adjustment granularity for setting manual gain or AGC target power levels
- Dual, full power outputs provided from each input to facilitate signal distribution or monitoring
- Dual fiber receivers on a single-slot card provides the industry's highest density solution
- The 7807LR-2-W is a dual channel card that features on-board fiber WDM, requiring only a single fiber for the link (companion transmitter is the 7807LT13/15-2-W)
- Fully hot-swappable from front of frame
- SmartMON™ capability for display of monitored parameters from companion SmartMON™ capable fiber transmitters
- VistaLINK® capability is available for monitoring and control when modules are used in a 3RU 7800FR frame and a 7700FC VistaLINK® frame controller is installed in slot 1 of the frame
- Form-C dry contact GPO alarm contacts for monitoring
- Fiber link provides electrical isolation between antenna and facility, mitigating ground loop and lightning issues
- Compatible with all 2408LT, 7706LT, 7708LT and 7807LT-2
- Wide range optical inputs (1270nm to 1610nm)
- Supports single-mode and multi-mode fiber optic cable
- Available with SC/UPC, ST/UPC, FC/UPC, SC/APC and FC/APC connector options
- The 7807LR-2/7807LR-2-H occupies one card slot and can be housed in a
- 1RU frame that will hold up to 3 modules, a 7800FR 3RU frame that will hold
- up to 15 modules, or a standalone enclosure which holds 1 module

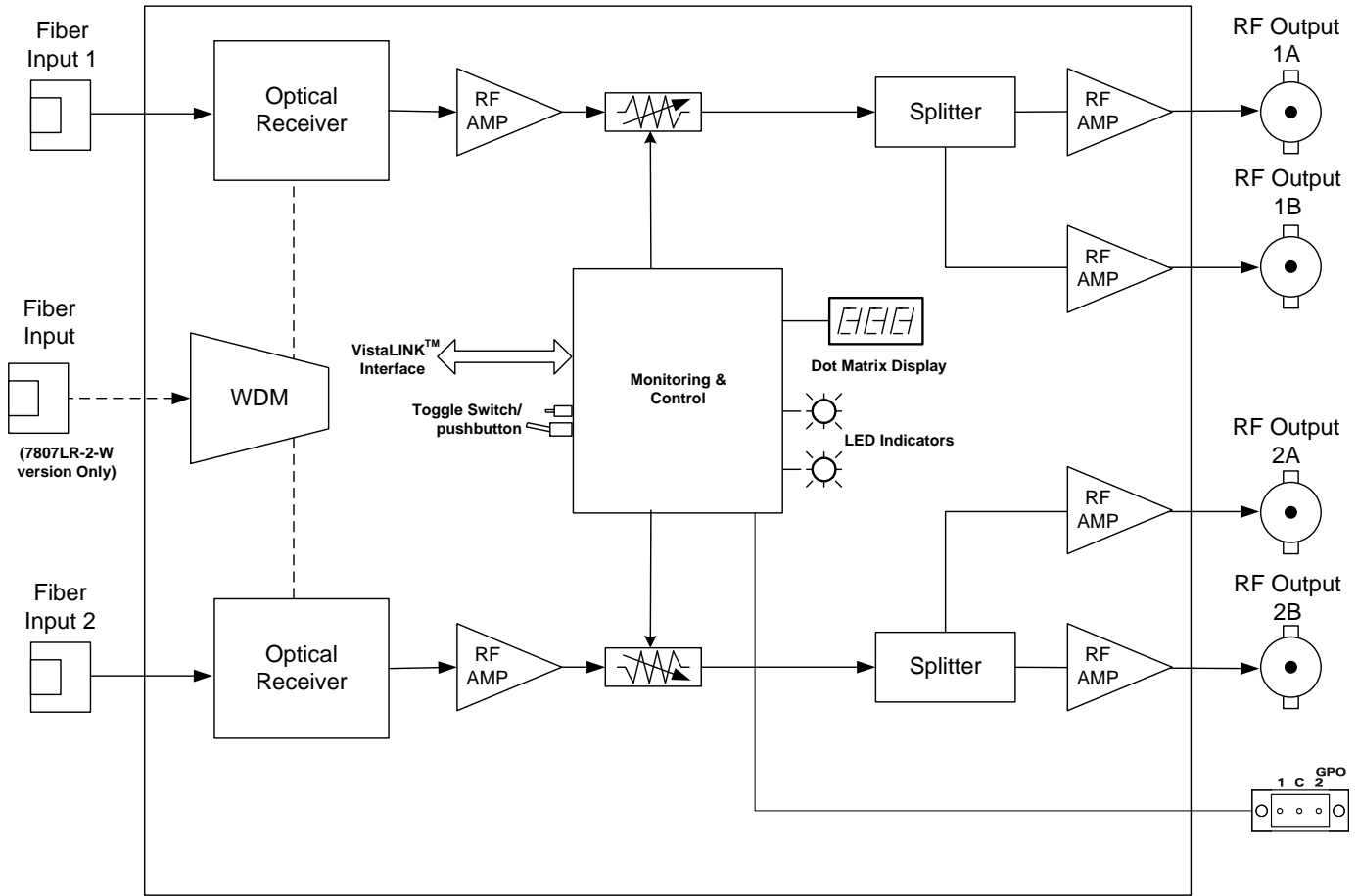

Figure 1-1: 7807LR-2/7807LR-2-H Block Diagram

2. INSTALLATION

The 7807LR-2/7807LR-2-H comes with a companion rear plate appropriate for a 1RU, 3RU or standalone enclosure as specified at the time of order. SC/UPC, SC/APC, ST/UPC, FC/UPC or FC/APC optical connectors are available and the type specified at the time of order will be installed. For information on mounting the rear plate and inserting the module into the frame, see the 7700/7800FR manual for detailed instructions.

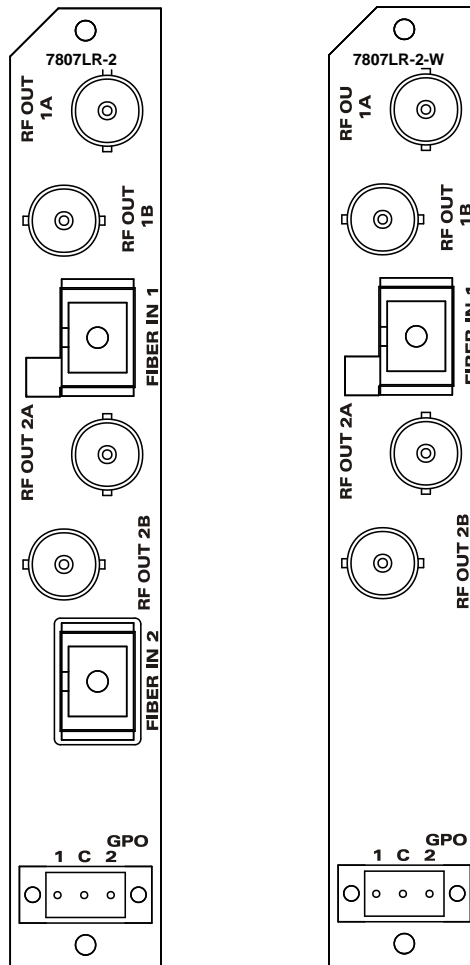

Figure 2-1: 7807LR-2/7807LR-2-W Rear Panel

2.1. 7807LR-2/7807LR-2-H CONNECTIONS

FIBER INPUTS: SC/UPC, SC/APC, ST/UPC, FC/UPC or FC/APC female connectors. This connector should be connected with suitable fiber optic cables to the optical outputs of an appropriate transmitter at the origin. The standard connector type is UPC. This connector type is compatible with standard PC connectors, but for optimal return loss performance, Evertz recommends the use of UPC fiber terminations throughout the system. The optional APC connectors provide further enhanced return loss performance, and when specified, should also be used throughout the system.

RF OUT: Two electrical output connectors for each received RF signals. The dual connectors provide an extra connector for monitoring or further distribution.

GPO's: The 3 pin terminal strip is used for the General Purpose Outputs (GPO). Pin1 and Pin2 refer to GPO1 and GPO2 respectively, whose behavior (NC/NO) can be selected by a jumper. (Refer to section 5.1 for Jumper Positions). Signal on GPO Common (C) is to be provided by the user. A minor alarm between Common and GPO1 is triggered in a state of RF exceeding threshold and major alarm between Common and GPO2 is triggered in a state of no optical power. Each GPO output is a set of normally open and normally closed relay contacts as shown in Figure 2-2.

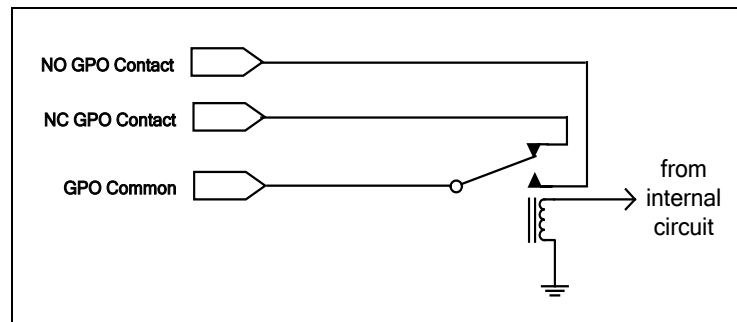

Figure 2-2: GPO Configuration



Please note: Unused connectors should be terminated with appropriate loading (50 or 75 Ohm).

2.2. CARE AND HANDLING OF OPTICAL FIBER

2.2.1. Handling and Connecting Fibers



Never touch the end face of an optical fiber. Always keep dust caps on optical fiber connectors when not connected and always remember to properly clean the optical end facet of a connector before making a connection.

The transmission characteristics of the fiber are dependent on the shape of the optical core and therefore care must be taken to prevent fiber damage due to heavy objects or abrupt fiber bending. Evertz recommends that you maintain a minimum bending radius of 5 cm to avoid fiber-bending loss that will decrease the maximum attainable distance of the fiber cable. Evertz fiber optic modules come with cable lockout devices to prevent the user from damaging the fiber by installing a module into a slot in the frame that does not have a suitable rear plate installed.

3. 7807LR-2/7807LR-2-H SPECIFICATIONS

3.1. RF OUTPUTS

Number of Outputs:	2 + 2 (two per optical input)
Connector:	BNC per IEC 61169-8 Annex A (F type optional)
Output Impedance:	75 Ω (50 Ω optional)
Return Loss:	>15dB
Frequency Range:	100MHz–2800MHz
Output IP3:	+28dBm
AGC Mode:	-10 to -40dBm (within AGC range)
Manual or IGC Mode:	-10 to -65dBm (depends on the RF input level, gain setting and optical loss)
IGC/AGC Hold Range:	-10 to +30dB



For detailed link performance specifications, see the Specifications section of the accompanying transmitter.

3.2. OPTICAL INPUTS

Number of Inputs:	2
Connector:	Female SC/UPC, SC/APC, ST/UPC, FC/UPC, FC/APC
Operating Wavelength:	1270nm - 1610nm
Optical Sensitivity:	
7807LR-2:	-14 dBm with \geq 35dB CNR*
7807LR-2-H:	-20 dBm with \geq 35dB CNR*
Maximum Input Power:	
7807LR-2:	+3dBm
7807LR-2-H:	-7dBm

- Tested 36MHz BW source, CNR > 35dB at the transmitter.

3.3. GENERAL PURPOSE OUTPUTS

Number of Outputs:	2
Type:	Dry relay contacts - NO and NC contact provided
Connector:	3 pin removable terminal strip

3.4. ELECTRICAL

Voltage:	+12VDC
Power:	6 Watts
GPO Common:	+12VDC, 250mA (Max switching Voltage and Current)
EMI/RFI:	Complies with FCC regulations for class A devices, Complies with EU EMC directive 89/336/EEC.

3.5. PHYSICAL

7800, 7701 and S7701 frame mounting:	
Number of slots:	1

4. STATUS INDICATORS AND DISPLAYS

4.1. 7807LR-2/7807LR-2-H STATUS INDICATORS

The 7807LR-2/7807LR-2-H has ten LED status indicators on the front card edge to show operational status of the card at a glance. See Figure 5-1 for LED locations.

Two large LEDs on the front of the board indicate the general health of the module:

LOCAL FAULT: This red LED indicates poor module health and will be on during the absence of a valid optical input signal or if a local internal power fault exists (i.e.: a blown fuse). Whether or not this LOCAL FAULT indication is reported to the frame may be selected by the FRAME STATUS jumper (see section 5.1).

MODULE OK: This green LED indicates good module health. It will be on when a valid optical input signal is present, and the board power is good.

There are 8 small LEDs that indicate the status of the output RF signal, and optical input signal.

OPTICAL INPUT STATUS CH1/CH2:

These LEDs will be yellow, respectively, when input optical powers on CH1 and CH2 are lower than or equal to the optical power low threshold settings. These will be green when the input optical powers are within threshold settings. These will be red when the input optical powers are higher than or equal to the optical power high threshold settings.

RF STATUS CH1/CH2:

These LEDs will be red, respectively, when the output RF signals on CH1 and CH2 are higher than or equal to threshold settings. These will be green when the output RF signals are within RF threshold settings. These will be yellow when the output RF signals are lower than or equal to the RF low threshold settings.

GAIN MODES CH1/CH2:

These LEDs are ON when AGC or IGC mode is enabled and OFF when Manual mode is enabled for CH1 and CH2. These will be green when power levels are within the AGC or IGC hold range and constant RF output levels are being maintained. These will be red if power levels are above the power levels required for the AGC/IGC circuit to be able to maintain a constant level. These will be yellow if power levels are below the power levels required for the AGC/IGC circuit to be able to maintain a constant level.

SQUELCH MODE CH1/CH2:

These LEDs are ON when squelch is enabled on respective Channel. These will be green when squelch modes are enabled but not active. These will be red when squelch modes are enabled and the output signals are squelched.

5. JUMPER POSITIONS

5.1. 7807LR-2/7807LR-2-H JUMPERS AND LEDS

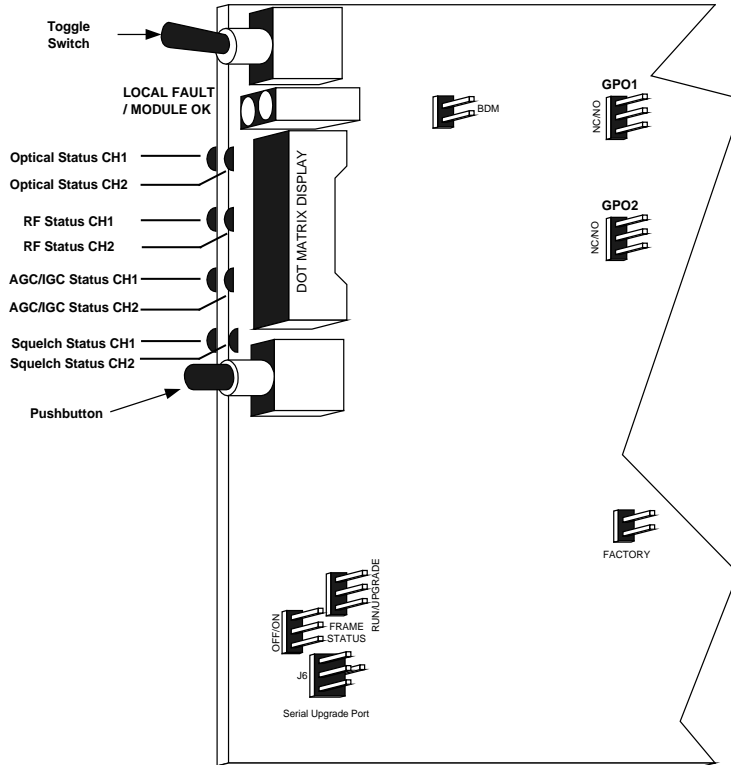

Figure 5-1: Location of 7807LR-2/7807LR-2-H Jumpers and LEDs

5.2. SELECTING WHETHER LOCAL FAULTS WILL BE MONITORED BY THE GLOBAL FRAME STATUS

The FRAME STATUS jumper J3 determines whether local faults (as shown by the Local Fault indicator) will be connected to the 7700/7800FR frame's global status bus.

FRAME STATUS: To monitor faults on this module with the frame status indicators (on the Power Supply FRAME STATUS LEDs and on the Frame's Fault Tally output) install this jumper in the ON position (default).

When this jumper is installed in the Off position local faults on this module will not be monitored.

5.3. CONFIGURING THE MODULE FOR FIRMWARE UPGRADES

UPGRADE: The UPGRADE jumper J5 is used when firmware upgrades are being done to the module. For normal operation it should be installed in the *RUN* position. See the *Upgrading Firmware* section of this manual for more information.

To upgrade the firmware:

1. Pull the module out of the frame.
2. Move the UPGRADE jumper into the *UPGRADE* position.
3. Install the Upgrade cable provided (located in the vinyl pouch in the front of this manual) onto the SERIAL header at the card edge.
4. Re-install the module into the frame.
5. Run the upgrade as described in the *Upgrading Firmware* section of this manual.
6. When the upgrade is completed, remove the module from the frame, move the UPGRADE jumper into the *RUN* position, remove the upgrade cable and re-install the module.

The module is now ready for normal operation.

Note that if installed in a frame with a 7700/7800FC frame controller, the 7807LR-2/7807LR-2-H may also be conveniently upgraded through Evertz VistaLINK PRO, without service interruption. Consult VistaLINK[®] PRO documentation for details on this feature.

5.4. FACTORY AND BDM JUMPERS

When shipped from the Evertz facility, the FACTORY and BDM jumpers will not be installed. These jumpers ***should not*** be installed for any reason. If jumpers are on these positions they should be removed.

5.5. GPO JUMPERS

The Jumpers GPO1 and GPO2 allow user to select the behavior of Outputs of GPO's.

In NC (Normally Closed) jumper position of GPO1, an OPEN circuit is present between C (common) pin and pin 1 of GPO connector and in NO (Normally Open) position of GPO1 a CLOSED circuit is present between C (common) pin and pin 1 of GPO connector.

In NC (Normally Closed) jumper position of GPO2, an OPEN circuit is present between C (common) pin and pin 2 of GPO connector and in NO (Normally Open) position of GPO2 a CLOSED circuit is present between C (common) pin and pin 2 of GPO connector.

6. DOT-MATRIX DISPLAY

Signal and status monitoring and control of the card's parameters are provided via the four-digit alphanumeric display located on the card edge. The card-edge toggle-switch (see Figure 5-1) is used to navigate through the display menus and the push button is used to select options. Figure 6-1 provides a quick reference to the display menu structure.

`CTRL` menu items have user-adjustable configuration values associated with them. `STAT` menu items display operating conditions or configuration values, but do not allow adjustment.

If a specific menu selection has a configuration value associated with it, then this may be changed using the toggle switch. Pressing the pushbutton will apply the displayed value and return you to the previous menu level.

The most recent user selection will be maintained in non-volatile memory in the event of power loss to the module.

Level 1	Level 2	Level 3	Level 4	Level 5	Level 6	
CTRL	RX	OPTH	LWR	CH1	-4 to -40 dBm Default -30 dBm	
				CH2	-4 to -40 dBm Default -30 dBm	
			UPPR	CH1	-3 to +5 dBm Default +5 dBm	
				CH2	-3 to +5 dBm Default +5 dBm	
		RFTH	LWR	CH1	-30 to -55 dBm Default -55 dBm	
				CH2	-30 to -55 dBm Default -55 dBm	
			UPPR	CH1	0 to -29 dBm Default -5 dBm	
				CH2	0 to -29 dBm Default -5 dBm	
			SQL	CH1	-40 to -65 dBm Default -60	
				CH2	-40 to -65 dBm Default -60	
		MODE	CH1	IGC MAN	See notes Default 0 dB	MAN -10 to -31.5dB IGC -10 to -31.5dB
				AGC (default)		
			CH2	IGC MAN		
				AGC (default)		
		GAIN (not visible in AGC Mode)	CH1	See notes Default 0 dB	See notes Default 0 dB	MAN -10 to -31.5dB IGC -10 to -31.5dB
			CH2	See notes Default 0 dB		
		OUTL (visible in AGC Mode only)	CH1	-10 to -40 dBm Default - 20 dBm	-10 to -40 dBm Default - 20 dBm	
			CH2	-10 to -40 dBm Default - 20 dBm		
		SQL	CH1	EN DIS (default)	EN DIS (default)	
			CH2	EN DIS (default)		



CTRL (continued)	TX	CH1	RFTH	LWR	-30 to -65 dBm Default -65 dBm
				UPPR	0 to -29 dBm Default -5 dBm
			TPTH (visible if TX is 2408LT,2407LT or 2407LTA)	LWR	-40 to 125°C Default 0°C
				UPPR	-40 to 125°C Default 0°C
			PPTH (visible if TX is 2408LT,2407LT or 2407LTA)	LWR	11 to 15 Volt Default 11V
				UPPR	16 to 23Volt Default 20V
		LCTH (not visible is TX is 2407LT or 2407 LTA)	LWR	0 to 500mA Default 0mA	
			UPPR	0 to 500mA Default 0mA	
		CH2	RFTH	LWR	-30 to -65 dBm Default -65 dBm
				UPPR	0 to -29 dBm Default -5 dBm
			TPTH (visible if TX is 2408LT,2407LT or 2407LTA)	LWR	-40 to 125°C Default 0°C
				UPPR	-40 to 125°C Default 0°C
	PPTH (visible if TX is 2408LT,2407LT or 2407LTA)		LWR	11 to 15 Volt Default 11V	
			UPPR	16 to 23Volt Default 20V	
	LCTH (not visible is TX is 2407LT or 2407 LTA)	LWR	0 to 500mA Default 0mA		
		UPPR	0 to 500mA Default 0mA		
	DISP	HORZ	Factory reset (leaves calibration offset alone)		
		VER (default)			
	FRST	YES			
		NO			

STAT	RX	OPWR	CH1	+7 to -40 dBm		
			CH2	+7 to -40 dBm		
		RPWR	CH1	0 to -55 dBm		
			CH2	0 to -55 dBm		
		SQL	CH1	DIS ACT NACT		
			CH2	DIS ACT NACT		
		TX	CH1	TONE	present/loss	
				INPL	0 to -60dBm	
	MODE			AGC MAN		
	GAIN			0-31.5		
	AGC			OFF LOW OK HIGH		
	RFDR (visible if TX is 2408LT,2407LT or 2407LTA)			HIGH OK LOW		
	OPWR					
	LASR			OK DEGR		
	PSU (visible if TX is 2408LT,2407LT or 2407LTA)			VOLT STAT	OK FAIL	
	TEMP (visible if TX is 2408LT,2407LT or 2407LTA)					
	LNB			OFF BYP, +13V, +13VT, +17V, +17VT, BYPT +18V		

STAT (continued)	TX (continued)		LNBV	if TX 2408LT,2407LTor 2407LTA	
			22KT		
			LNBC		
			VER		
			TYPE		
			SER	If TX is 2408LT	
		CH2	TONE	present/loss	
			INPL	0 to -60dBm	
			MODE	AGC MAN	
			GAIN	0-31.5	
			AGC	OFF LOW OK HIGH	
			RFDR (visible if TX is 2408LT,2407LT or 2407LTA)	HIGH OK LOW	
			OPWR		
			LASR	OK DEGR	
	PSU (visible if TX is 2408LT,2407LT or 2407LTA)		VOLT		
			STAT	OK FAIL	
	TEMP (visible if TX is 2408LT,2407LT or 2407LTA)				
	LNBM	OFF BYP, +13V, +13VT, +17V, +17VT, BYPT +18V			
		LNBV			
		22KT			
		LNBC			
		VER			
		TYPE			
		SER	If TX is 2408LT		
	VER		Firmware Version		

Figure 6-1: Card Edge Menu Structure

6.1. 7807LR-2/7807LR-2-H CONTROLLED PARAMETERS

To change the 7807LR-2/7807LR-2-H parameters, select the **CTRL** menu item in menu level 1. Use the toggle switch to select the **RX** menu item and press the pushbutton. The toggle switch may then be used to select the parameter to change as described below:

6.1.1. Adjusting the Optical Power Alarm Thresholds

The 7807LR-2/7807LR-2-H measures and can display the input optical power over a range of +7dBm to –40dBm in increments of 1dBm. Alarm points may be set for high input optical power, and low input optical power. These alarms will appear locally on the card edge LEDs (see Section 3) and remotely via SNMP traps. To adjust the optical power alarm thresholds, select the **CTRL** menu item in the first menu level, then use the toggle switch to display the **RX** option and press the pushbutton to select it. Use the toggle switch to display the **OPTH** option and press the pushbutton to select it. Use the toggle switch to then select from the **UPPR** and **LWR** thresholds. Choices are as follows:

CTRL			
RX			
OPTH			
LWR			
CH1/CH2			
-1 to -40 dBm			
-4 to -40 dBm			7807LR-2: Lower optical power alarm threshold (default -14 dBm).
CTRL			
RX			
OPTH			
UPPR			
CH1/CH2			
+3 to -3 dBm			7807LR-2: Upper optical power alarm threshold (default +3 dBm).
-7 to -13 dBm			7807LR-2-H: Upper optical power alarm threshold (default -7 dBm).

6.1.2. Adjusting the RF Output Power Alarm and Squelch Thresholds

The 7807LR-2/7807LR-2-H measures and can display the output RF power over a range of 0dBm to –60dBm in increments of 1dBm. Alarms may be set for high and low output RF power that will appear locally on the card edge LEDs (see Section 3) and remotely via SNMP traps. To set the alarm threshold points, select the **CTRL** menu item in the first menu level, then use the toggle switch to display the **RX** option and press the pushbutton to select it. Use the toggle switch to display the **RFTH** option and press the pushbutton to select it. Use the toggle switch to then select from the **UPPR** and **LWR** thresholds. Choices are as follows:

CTRL	-30 to -55 dBm	Lower RF power alarm threshold (default -55 dBm).
RX		
RFTH		
LWR		
CH1/CH2		
	-30 to -55 dBm	
CTRL	0 to -29 dBm	Upper optical power alarm threshold (default -5 dBm).
RX		
RFTH		
UPPR		
CH1/CH2		
	0 to -29 dBm	

Additionally, the RF Squelch threshold may be set from this menu via the `SQL` selection. The squelch level is based on the RF input power to the transmitter, and therefore this threshold feature will only function when a compatible transmitter that sends monitoring information down the fiber is connected, such as the 2407LT.

CTRL	-40 to -65 dBm	RF power entering at the transmitter at which point the output should be squelched (default -60 dBm).
RX		
RFTH		
SQL		
CH1/CH2		
	-40 to -65 dBm	

6.1.3. Selecting the Output Gain Mode

The 7807LR-2/7807LR-2-H has several gain modes available:

Manual gain mode allows the user to select a fixed gain level for the RF signal.

AGC (automatic gain control) will maintain a constant output level even if the input RF level changes, as long as this input level does not go outside of the AGC hold range. The AGC target level is user adjustable (see Section 6.1.5).

IGC mode compensates for optical loss and outputs an RF signal level proportional to what is coming into the transmitter, within the signal level capabilities of the receiver. The IGC mode is based on the RF input power to the transmitter, and therefore this feature will only function when a transmitter featuring SmartMON™ is used. With no gain applied, the output signal from the 7807LR-2/7807LR-2-H will be at the same level as the input to the transmitter. Additional gain may be applied to this signal level (see next section) as an offset. **Note that this mode will not be available unless an appropriate SmartMON™ capable transmitter that sends monitoring data down the fiber is connected.**

To select the gain mode, select the `CTRL` menu item in the first menu level, then use the toggle switch to display the `RX` option and press the pushbutton to select it. Use the toggle switch to display the `MODE` option and press the pushbutton to select it.

CTRL	AGC	AGC mode (default).
RX	IGC	IGC mode.
MODE	MAN	Manual mode.
CH1/CH2		
AGC		
IGC		
MAN		

6.1.4. Adjusting the RF Output Gain

The 7807LR-2/7807LR-2-H can apply gain to adjust the level of the output signal in 0.5 dB increments. Gain may be applied when the card is set for manual or IGC modes (see previous section). To set the gain, select the CTRL menu item in the first menu level, then use the toggle switch to display the RX option and press the pushbutton to select it. Use the toggle switch to display the GAIN option and press the pushbutton to select it.

CTRL	-10 to +31.5 dBm Output signal gain level (default 0 dBm).
RX	
GAIN	
CH1/CH2	
-10 to +31.5 dBm	



Note that this menu item is not applicable and therefore not visible when in AGC mode.

6.1.5. Adjusting the AGC Target Level

The target output level to be maintained by the 7807LR-2/7807LR-2-H when in AGC mode is user adjustable. To set the AGC target level, select the CTRL menu item in the first menu level, then use the toggle switch to display the RX option and press the pushbutton to select it. Use the toggle switch to display the OUTL option and press the pushbutton to select it.

CTRL	-10 to -40 dBm AGC output signal target level (default -20 dBm).
RX	
OUTL	
CH1/CH2	
-10 to -40 dBm	



Note that this menu item is only applicable and visible when the card is set to operate in AGC mode.

6.1.6. Enabling/Disabling Squelch Mode

Squelch mode will turn off the RF output if it drops below a certain input power level as reported by the transmitter (see section 6.1.2) or if the input optical power drops below -40 dBm. To enable or disable squelch mode, select the **CTRL** menu item in the first menu level, then use the toggle switch to display the **RX** option and press the pushbutton to select it. Use the toggle switch to display the **SQL** option and press the pushbutton to select it. Use the toggle switch to display the **EN** option and press the pushbutton to select it. Use the toggle switch to display the **DIS** option and press the pushbutton to select it.

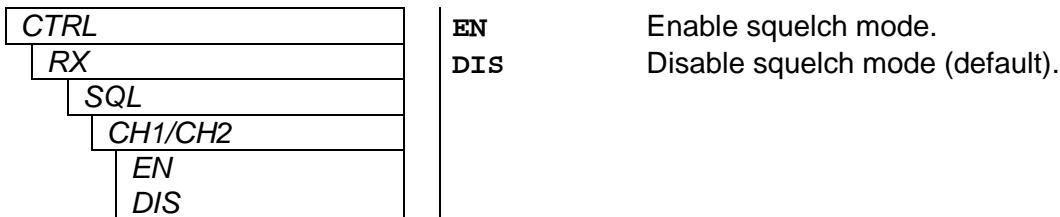

6.1.7. Setting the Card Edge Display Orientation

The **DISP** display option allows the user to set a horizontal or vertical orientation for the card edge display messages. To set the display orientation, select the **CTRL** menu item in menu level 1, then use the toggle switch to display the **DISP** menu selection and use the pushbutton to select it. Use the toggle switch to change between **HOR** and **VERT**. Press the push button to make your selection.

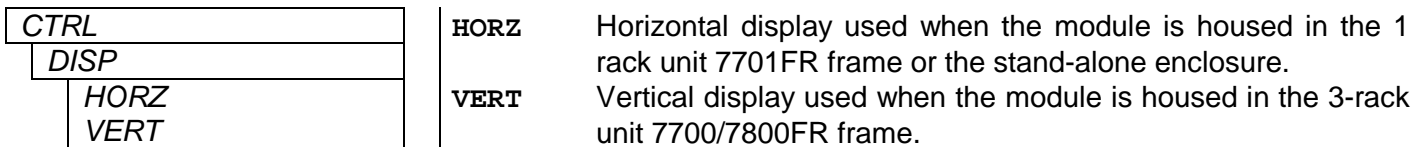

6.1.8. Resetting Factory Defaults

The **FRST** menu option will return the 7807LR-2/7807LR-2-H to factory defaults. To return all settings to factory defaults, select the **CTRL** menu item in menu level 1, then use the toggle switch to display the **FRST** menu selection and use the pushbutton to select it.

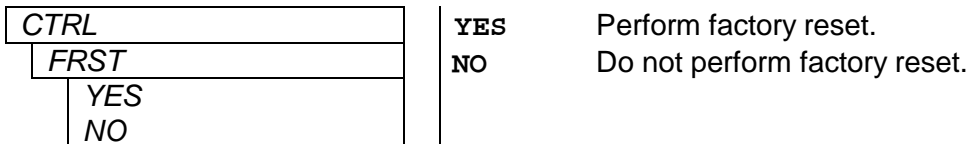

6.2. TRANSMITTER CONTROLLABLE PARAMETERS

The 7807LR-2/7807LR-2-H can decode and display monitoring data sent across the fiber by compatible Evertz transmitters featuring SmartMON™. Several of these monitored parameters are suitable for alarming via SNMP/VistaLINK. The thresholds for these alarms may be adjusted via the card edge or through SNMP. **Note that these menu items will not be available unless an appropriate SmartMON™ equipped transmitter that sends monitoring data down the fiber is connected.**



Note: Not all compatible transmitter models have the same controllable parameters - only those applicable to the specific transmitter model will be available. See the following table for parameters related to the connected transmitter.

Parameter	2407LTA	2408LT	7708LT	7807LT-2
RF Power Alarm Thresholds	X	X	X	X
Temperature Alarm Thresholds	X	X		
Input DC Alarm Thresholds	X	X		
LNB Current Alarm Thresholds		X	X	X

6.2.1. Adjusting the RF Input Power Alarm Thresholds

SNMP alarms may be set for high and low input RF power to the transmitter. To set the alarm threshold points, select the **CTRL** menu item in the first menu level, then use the toggle switch to display the **TX** option and press the pushbutton to select it. Use the toggle switch to display the **RFTH** option and press the pushbutton to select it. Use the toggle switch to then select from the **UPPR** and **LWR** thresholds. Choices are as follows:

CTRL	-30 to -65 dBm	Lower RF power alarm threshold (default -65 dBm).
TX		
CH1/CH2		
RFTH		
LWR		
-30 to -65 dBm		

CTRL	0 to -29 dBm	Upper optical power alarm threshold (default -5 dBm).
TX		
CH1/CH2		
RFTH		
UPPR		
0 to -29 dBm		

6.2.2. Adjusting the Internal Transmitter Temperature Alarm Thresholds

SNMP alarms may be set for high and low internal temperature readings at the transmitter. To set the alarm threshold points, select the **CTRL** menu item in the first menu level, then use the toggle switch to display the **TX** option and press the pushbutton to select it. Use the toggle switch to display the **TPTH** option and press the pushbutton to select it. Use the toggle switch to then select from the **UPPR** and **LWR** thresholds. Choices are as follows:

CTRL	-40 to +125 deg C.	Lower temperature alarm threshold (default 0 deg C.)
TX		
CH1/CH2		
TPTH		
LWR		
-40 to +125 deg C.		

CTRL	-40 to +125 deg C.	Upper temperature alarm threshold (default 85 deg C.)
TX		
CH1/CH2		
TPTH		
UPPR		
-40 to +125 deg C.		

6.2.3. Adjusting the Input Voltage Alarm Thresholds

SNMP alarms may be set for high and low DC input Voltage at the transmitter. To set the alarm threshold points, select the CTRL menu item in the first menu level, then use the toggle switch to display the TX option and press the pushbutton to select it. Use the toggle switch to display the PPTH option and press the pushbutton to select it. Use the toggle switch to then select from the UPPR and LWR thresholds.

CTRL	11 to 15 VDC	Lower input voltage alarm threshold (default 11 VDC.)
TX		
CH1/CH2		
PPTH		
LWR		
11 to 15 VDC		

CTRL	16 to 23 VDC	Upper input voltage alarm threshold (default 20 VDC.)
TX		
CH1/CH2		
PPTH		
UPPR		
16 to 23 VDC		

6.2.4. Adjusting the LNB Current Alarm Thresholds

SNMP alarms may be set for high and low LNB current at the transmitter, providing a convenient means of remotely monitoring LNB condition. To set the alarm threshold points, select the CTRL menu item in the first menu level, then use the toggle switch to display the TX option and press the pushbutton to select it. Use the toggle switch to display the LCTH option and press the pushbutton to select it. Use the toggle switch to then select from the UPPR and LWR thresholds.

CTRL	0 to 500 mA	Lower LNB current alarm threshold (default 0 mA.)
TX		
CH1/CH2		
LCTH		
LWR		
0 to 500 mA		

CTRL	0 to 500 mA	Upper input voltage alarm threshold (default 500 mA.)
TX		
CH1/CH2		
LCTH		
UPPR		
0 to 500 mA		

6.3. 7807LR-2/7807LR-2-H MONITORED CONDITIONS AND PARAMETERS

To view the 7807LR-2/7807LR-2-H monitored parameters, select the *STAT* menu item in menu level 1. Use the toggle switch to select the *RX* menu item and press the pushbutton. The toggle switch may then be used to select the parameter to view as described below:

6.3.1. Displaying the Input Optical Power

The 7807LR-2/7807LR-2-H measures and can display the input optical power over a range of +7dBm to –40dBm in increments of 1dBm. To display the input optical power, select the *STAT* menu item in the first menu level, then use the toggle switch to display the *RX* option and press the pushbutton to select it. Use the toggle switch to display the *OPWR* option and press the pushbutton to select it.

STAT	+7 to -40	Optical input power within this range.
RX	LOW	Input optical power low (< -40 dBm).
OPWR		
CH1/CH2		
+7 to -40 dBm		
LOW		

6.3.2. Displaying the Output RF Power

The 7807LR-2/7807LR-2-H measures and can display the output RF power over a range of 0dBm to –60dBm in increments of 1dBm. To display the output RF power, select the *STAT* menu item in the first menu level, then use the toggle switch to display the *RX* option and press the pushbutton to select it. Use the toggle switch to display the *OPWR* option and press the pushbutton to select it.

STAT	0 to -60 dBm	Output RF power within this range.
RX		
RPWR		
CH1/CH2		
0 to -60 dBm		

6.3.3. Displaying the Squelch Status

To display the squelch mode setting and status, select the *STAT* menu item in the first menu level, then use the toggle switch to display the *RX* option and press the pushbutton to select it. Use the toggle switch to display the *SQL* option and press the pushbutton to select it.

STAT
RX
SQL
CH1/CH2
DIS
ACT
NACT

DIS	Squelch mode disabled.
ACT	Squelch mode enabled and active (output signal squelched).
NACT	Squelch mode enables and not active.

6.4. TRANSMITTER MONITORED PARAMETERS

The 7807LR-2/7807LR-2-H can decode and display monitoring data sent across the fiber by compatible Evertz transmitters featuring SmartMON™. To view the monitored parameters of the connected transmitter, select the STAT menu item in menu level 1. Use the toggle switch to select the TX menu item and press the pushbutton. The toggle switch may then be used to select the parameter to view as described below. Note that these parameters will not be available for viewing unless the connected transmitter has the feature to send monitoring data down the fiber.



Note: Not all compatible transmitter models send the same parameters – only those applicable to the specific transmitter model will be displayed. See the following table for parameters related to the connected transmitter.

Parameter	2407LTA	2408LT	7708LT	7807LT-2
Input RF Level	X	X	X	X
Gain Mode	X	X	X	X
Applied Gain	X	X	X	X
AGC Status	X	X	X	X
RF Drive	X	X	X	X
Optical Output Power	X	X	X	X
Laser Status	X	X	X	X
Power Supply Status	X	X		
Internal Temperature	X	X		
LNB Power Mode	X	X		
LNB Voltage	X	X	X	X
LNB Current		X	X	X
Firmware Version	X	X	X	X
Transmitter Model	X	X	X	X

6.4.1. Displaying the Presence of the Data Signal

The 7807LR-2/7807LR-2-H detects and can display the presence or loss of the SmartMON™ data signal from a companion transmitter. To display the status of this data signal, select the STAT menu item in the first menu level, then use the toggle switch to display the TX option and press the pushbutton to select it. Use the toggle switch to display the TONE option and press the pushbutton to select it.

STAT	PRES	Data signal from connected transmitter present.
TX	LOSS	No data signal detected.
CH1/CH2		
TONE		
PRES		
LOSS		



Note: The following menu items will not be displayed unless the data signal from a SmartMON™ equipped transmitter is detected.

6.4.2. Displaying the Input RF Power to the Connected Transmitter

To display the input RF power to the transmitter, select the *STAT* menu item in the first menu level, then use the toggle switch to display the *TX* option and press the pushbutton to select it. Use the toggle switch to display the *INPL* option and press the pushbutton to select it.

STAT	+10 to -65	Input RF power in dBm.
TX		
CH1/CH2		
INPL		
+10 to -65		

6.4.3. Displaying the Gain Mode of the Connected Transmitter

To display the gain mode of the connected transmitter, select the *STAT* menu item in the first menu level, then use the toggle switch to display the *TX* option and press the pushbutton to select it. Use the toggle switch to display the *MODE* option and press the pushbutton to select it.

STAT	AGC	Gain mode is AGC (automatic gain control).
TX	MAN	Gain mode is manual.
CH1/CH2		
MODE		
AGC		
MAN		

6.4.4. Displaying the Gain Level of the Connected Transmitter

To display the gain level of the connected transmitter, select the *STAT* menu item in the first menu level, then use the toggle switch to display the *TX* option and press the pushbutton to select it. Use the toggle switch to display the *GAIN* option and press the pushbutton to select it.

STAT	0 to 31 dB	Gain level set either manually, or automatically applied by the transmitter if in AGC mode.
TX		
CH1/CH2		
GAIN		
0 to 31 dB		

6.4.5. Displaying the AGC Status of the Connected Transmitter

To display the AGC Status of the connected transmitter, select the *STAT* menu item in the first menu level, then use the toggle switch to display the *TX* option and press the pushbutton to select it. Use the toggle switch to display the *AGC* option and press the pushbutton to select it.

STAT	OFF	AGC mode is off (transmitter is set for manual gain mode).
TX		
CH1/CH2		
AGC		
OFF OK HIGH LOW		

6.4.6. Displaying the RF Drive Status of the Connected Transmitter

To display the RF Drive status of the connected transmitter, select the *STAT* menu item in the first menu level, then use the toggle switch to display the *TX* option and press the pushbutton to select it. Use the toggle switch to display the *RFDR* option and press the pushbutton to select it.

STAT	HIGH	Laser is being over driven – this may appear as IMD products on the received signal.
TX		
CH1/CH2		
RFDR		
HIGH OK LOW		

6.4.7. Displaying the Output Optical Power of the Connected Transmitter

To display the output optical power of the connected transmitter, select the *STAT* menu item in the first menu level, then use the toggle switch to display the *TX* option and press the pushbutton to select it. Use the toggle switch to display the *OPWR* option and press the pushbutton to select it.

STAT	+10 to -10 dBm	Laser output power.
TX		
CH1/CH2		
OPWR		
+10 to -10 dBm		

6.4.8. Displaying the Laser Status of the Connected Transmitter

To display the laser status of the connected transmitter, select the *STAT* menu item in the first menu level, then use the toggle switch to display the *TX* option and press the pushbutton to select it. Use the toggle switch to display the *LASR* option and press the pushbutton to select it.

<div style="border: 1px solid black; padding: 2px; margin-bottom: 2px;">STAT</div> <div style="border: 1px solid black; padding: 2px; margin-bottom: 2px; margin-left: 20px;">TX</div> <div style="border: 1px solid black; padding: 2px; margin-bottom: 2px; margin-left: 40px;">CH1/CH2</div> <div style="border: 1px solid black; padding: 2px; margin-bottom: 2px; margin-left: 60px;">LASR</div> <div style="border: 1px solid black; padding: 2px; margin-bottom: 2px; margin-left: 80px;">DGRD</div> <div style="border: 1px solid black; padding: 2px; margin-left: 100px;">OK</div>	<div style="border-left: 1px solid black; padding-left: 5px;">OK</div> <div style="border-left: 1px solid black; padding-left: 5px;">DGRD</div>	<div style="border-left: 1px solid black; padding-left: 5px;">Laser is operating normally.</div> <div style="border-left: 1px solid black; padding-left: 5px;">Laser operation is degraded, or laser has reached approximately 80% of its useful lifespan.</div>
--	---	--

6.4.9. Displaying Status of the Power Supply Connected to the Transmitter

To display the status of the power supply connected to the transmitter, select the *STAT* menu item in the first menu level, then use the toggle switch to display the *TX* option and press the pushbutton to select it. Use the toggle switch to display the *PSU* option and press the pushbutton to select it. Then select from *VOLT* to show the DC input voltage to the transmitter as provided by the power supply, or select *STAT* to check the status of the internal power supplies (applicable only on Evertz power supplies capable of sending monitoring information to the transmitter).

<div style="border: 1px solid black; padding: 2px; margin-bottom: 2px;">STAT</div> <div style="border: 1px solid black; padding: 2px; margin-bottom: 2px; margin-left: 20px;">TX</div> <div style="border: 1px solid black; padding: 2px; margin-bottom: 2px; margin-left: 40px;">CH1/CH2</div> <div style="border: 1px solid black; padding: 2px; margin-bottom: 2px; margin-left: 60px;">PSU</div> <div style="border: 1px solid black; padding: 2px; margin-bottom: 2px; margin-left: 80px;">VOLT</div> <div style="border: 1px solid black; padding: 2px; margin-left: 100px;">18 to 23 VDC</div>	<div style="border-left: 1px solid black; padding-left: 5px;">18 to 23 VDC</div>	<div style="border-left: 1px solid black; padding-left: 5px;">DC Voltage level entering the transmitter</div>
---	--	---

<div style="border: 1px solid black; padding: 2px; margin-bottom: 2px;">STAT</div> <div style="border: 1px solid black; padding: 2px; margin-bottom: 2px; margin-left: 20px;">TX</div> <div style="border: 1px solid black; padding: 2px; margin-bottom: 2px; margin-left: 40px;">CH1/CH2</div> <div style="border: 1px solid black; padding: 2px; margin-bottom: 2px; margin-left: 60px;">PSU</div> <div style="border: 1px solid black; padding: 2px; margin-bottom: 2px; margin-left: 80px;">STAT</div> <div style="border: 1px solid black; padding: 2px; margin-left: 100px;">OK</div> <div style="border: 1px solid black; padding: 2px; margin-left: 100px;">FAIL</div>	<div style="border-left: 1px solid black; padding-left: 5px;">OK</div> <div style="border-left: 1px solid black; padding-left: 5px;">FAIL</div>	<div style="border-left: 1px solid black; padding-left: 5px;">Connected power supply internal modules are both OK.</div> <div style="border-left: 1px solid black; padding-left: 5px;">One internal module in the connected power supply has failed and redundancy has been lost.</div>
--	---	---

6.4.10. Displaying the Internal Temperature of the Connected Transmitter

To display the internal temperature of the connected transmitter, select the *STAT* menu item in the first menu level, then use the toggle switch to display the *TX* option and press the pushbutton to select it. Use the toggle switch to display the *TEMP* option and press the pushbutton to select it.

STAT	-40 to +125 deg C. Internal temperature of the connected transmitter.
TX	
CH1/CH2	
TEMP	
-40 to +125 deg C.	

6.4.11. Displaying the LNB Mode of the Connected Transmitter

To display the LNB Mode of the connected transmitter, select the *STAT* menu item in the first menu level, then use the toggle switch to display the *TX* option and press the pushbutton to select it. Use the toggle switch to display the *LNBM* option and press the pushbutton to select it.

STAT	OFF LNB supply is turned off. 13V LNB supply is set for 13VDC. 13VT LNB supply is set for 13VDC + 22kHz. 17V LNB supply is set for 17VDC. 17VT LNB supply is set for 17VDC + 22kHz. BYP LNB supply is set for DC Pass mode and LNB power is supplied directly by the connected power supply. BYPT LNB supply is set for DC Pass +22kHz mode and LNB power is supplied directly by the connected power supply.
TX	
CH1/CH2	
LNBM	
OFF	
13V	
13VT	
17V	
17VT	
BYP	
BYPT	

6.4.12. Displaying the LNB Voltage of the Connected Transmitter

To display the LNB Voltage of the connected transmitter, select the *STAT* menu item in the first menu level, then use the toggle switch to display the *TX* option and press the pushbutton to select it. Use the toggle switch to display the *LNBNV* option and press the pushbutton to select it.

STAT	0 to 23 VDC Voltage supplied to the LNB as specified by the LNB mode setting, or as provided by the connected power supply if in DC PASS mode.
TX	
CH1/CH2	
LNBNV	
0 to 23 VDC	

6.4.13. Displaying the LNB Current

To display the LNB Current, select the *STAT* menu item in the first menu level, then use the toggle switch to display the *TX* option and press the pushbutton to select it. Use the toggle switch to display the *LNBNBC* option and press the pushbutton to select it.

STAT	Indicates the LNB current. Visible for -LNB versions only.
TX	
CH1/CH2	
LNBNBC	
0 to 500A RF current range.	

6.4.14. Displaying the Firmware Version of the Connected Transmitter

To display the firmware version of the connected transmitter, select the `STAT` menu item in the first menu level, then use the toggle switch to display the `TX` option and press the pushbutton to select it. Use the toggle switch to display the `VER` option and press the pushbutton to select it. The firmware version will scroll across the display.

For example: `VER 1.0 BUILD 006`

6.4.15. Displaying the Model of the Connected Transmitter

To display the model of the connected transmitter, select the `STAT` menu item in the first menu level, then use the toggle switch to display the `TX` option and press the pushbutton to select it. Use the toggle switch to display the `TYPE` option and press the pushbutton to select it. The model will scroll across the display.

For example: `2408LT`

7. VISTALINK[®] REMOTE MONITORING/CONTROL

7.1. WHAT IS VISTALINK[®]?

VistaLINK[®] is Evertz's remote monitoring and configuration platform which operates over an Ethernet network using Simple Network Management Protocol (SNMP). SNMP is a standard computer network protocol that enables different devices sharing the same network to communicate with each other. VistaLINK[®] provides centralized alarm management, which monitors, reports, and logs all incoming alarm events and dispatches alerts to all the VLPro Clients connected to the server. Card configuration through VistaLINK[®] PRO can be performed on an individual or multi-card basis using simple copy and paste routines, which reduces the time to configure each module separately. Finally, VistaLINK[®] enables the user to configure devices in the network from a central station and receive feedback that the configuration has been carried out.

There are 3 components of SNMP:

1. An SNMP manager, also known as a Network Management System (NMS), is a computer running special software that communicates with the devices in the network. Evertz VistaLINK[®] Pro Manager graphical user interface (GUI), third party or custom manager software may be used to monitor and control Evertz VistaLINK[®] enabled fiber optic products.
2. Managed devices, each with a unique address (OID), communicate with the NMS through an SNMP Agent. Evertz VistaLINK[®] enabled 7700/7800 series modules reside in the 3RU 7700/7800FR-C MultiFrame and communicate with the manager via the 7700/7800FC VistaLINK[®] frame controller module, which serves as the Agent.
3. A virtual database, known as the Management Information Base (MIB), lists all the variables being monitored, which both the Manager and Agent understand. Please contact Evertz for further information about obtaining a copy of the MIB for interfacing to a third party Manager/NMS.

For more information on connecting and configuring the VistaLINK[®] network, see the 7700/7800FC Frame Controller chapter.

7.1.1. VISTALINK[®] Monitored Parameters

Parameter	Description
Optical Power	Receiver Input Optical Power
RF Output Power	Receiver RF output power
Gain	Receiver gain setting
Squelch	Receiver squelch status
Firmware Version	Receiver firmware version
RF Input Power	Transmitter RF input power
Gain Mode	Transmitter gain mode
Gain	Transmitter applied gain
AGC State	Transmitter AGC state
RF Drive	Transmitter RF drive status
Optical Output Power	Transmitter optical output power
LASER Status	Transmitter laser status
DC Input power	Transmitter DC input power
PSU Redundant Supply Status	Transmitter connected DC power supply status
LNB Control Setting	Transmitter LNB mode setting
LNB Voltage	Transmitter LNB voltage
LNB Current	Transmitter current supplied to connected LNB
Temperature	Transmitter internal temperature
Firmware Version	Transmitter firmware version
Transmitter Model	Transmitter model

Table 7-1: VistaLINK[®] Monitored Parameters

7.1.2. VISTALINK[®] Controlled Parameters

Parameter	Description
Lower Optical Power Threshold	Receiver low optical power alarm threshold
Upper Optical Power Threshold	Receiver high optical power alarm threshold
Lower RF Output Power Threshold	Receiver low RF power alarm threshold
Upper RF Output Power Threshold	Receiver high RF power alarm threshold
Gain	Receiver Output signal gain
AGC RF Output Level	Receiver AGC target level
Gain Mode	Receiver Gain mode (manual, AGC, IGC)
Squelch	Receiver Squelch mode enable/disable
Squelch Threshold	Receiver Squelch threshold setting
Lower RF Input Power Threshold	Transmitter low RF power alarm threshold
Upper RF Input Power Threshold	Transmitter high RF power alarm threshold
Lower Temperature Threshold	Transmitter low temperature power alarm threshold
Upper Temperature Threshold	Transmitter high temperature power alarm threshold
Lower DC Supply Input Voltage Threshold	Transmitter low DC input voltage alarm threshold
Upper DC Supply Input Voltage Threshold	Transmitter high DC input voltage alarm threshold

Lower LNB Current Threshold	Transmitter low LNB current alarm threshold
Upper LNB Current Threshold	Transmitter high LNB current alarm threshold

Table 7-2: VistaLINK® Controlled Parameters

7.1.3. VISTALINK® Traps

Traps	Description
RF Output Power High	Receiver RF output high
RF Output Power Low	Receiver RF output low
Optical Input Power High	Receiver optical input high
Optical Input Power Low	Receiver optical input low
AGC out of Range	Receiver out of AGC range
Squelch Active	Receiver output signal squelched
RF Input Power High	Transmitter RF input high
RF Input Power Low	Transmitter RF input low
Temperature High	Transmitter temperature high
Temperature Low	Transmitter temperature low
DC Supply High	Transmitter DC input voltage high
DC Supply Low	Transmitter DC input voltage low
RF Drive High	Transmitter RF Drive high
RF Drive Low	Transmitter RF Drive low
LNB Current High	Transmitter LNB current high
LNB Current Low	Transmitter LNB current low
LNB Short	LNB current overload or short circuit

Table 7-3: VistaLINK® Traps