

MVP™ USER MANUAL

© Copyright 2005 - 2013

EVERTZ MICROSYSTEMS LTD.

5288 John Lucas Drive,
Burlington, Ontario,
Canada L7L 5Z9

Phone: 905-335-3700

Sales: sales@evertz.com Fax: 905-335-3573

Tech Support: service@evertz.com Fax: 905-335-7571



Web Page: <http://www.evertz.com>

Version 2.8.7, May 2013

The material contained in this manual consists of information that is the property of Evertz Microsystems and is intended solely for the use of purchasers of the MVP™ and MVP Maestro™. Evertz Microsystems expressly prohibits the use of this manual for any purpose other than the operation of the MVP™ and MVP Maestro™. Due to on going research and development, features and specifications in this manual are subject to change without notice.

All rights reserved. No part of this publication may be reproduced without the express written permission of Evertz Microsystems Ltd. Copies of this manual can be ordered from your Evertz dealer or from Evertz Microsystems.

IMPORTANT SAFETY INSTRUCTIONS

	The lightning flash with arrowhead symbol within an equilateral triangle is intended to alert the user to the presence of un-insulated, dangerous voltage within the product's enclosure that may be of sufficient magnitude to constitute a risk of electric shock to persons.
	The exclamation point within an equilateral triangle is intended to alert the user to the presence of important operating and maintenance (i.e.: servicing) instructions in the literature accompanying the product.

- Read these instructions.
- Keep these instructions.
- Heed all warnings.
- Follow all instructions.
- Don't use this apparatus near water.
- Clean only with a dry cloth.
- Don't block any ventilation openings.
- Install in accordance with the manufacturer's instructions.
- Don't install near any heat sources such as radiators, heat registers, stoves, or other apparatuses (including amplifiers) that produce heat.
- Don't defeat the safety purpose of the polarized or grounding-type plug. A polarized plug has two blades with one wider than other. A grounding-type plug has two blades and a third grounding prong. The wide blade or third prong is provided for your safety. If the plug provided does not fit into your outlet, consult an electrician to replace the obsolete outlet.
- Protect the power cord from being walked on or pinched, particularly at plugs, convenience receptacles, and the point where they exit from the apparatus.
- Only use attachments/accessories specified by the manufacturer
- Unplug this apparatus during lightning storms, or when unused for long periods of time.
- Refer all servicing to qualified service personnel. Servicing is required when the apparatus has been damaged in any way, such as damage to the power-supply cord or plug, contact with liquid (or any object small enough to enter the apparatus), exposure to rain or moisture, drop damage, or upon experiencing any abnormal operation.

WARNING:

TO REDUCE THE RISK OF FIRE OR ELECTRIC SHOCK, **DO NOT** EXPOSE THIS APPARATUS TO RAIN OR MOISTURE

WARNING:

DO NOT EXPOSE THIS EQUIPMENT TO DRIPPING OR SPLASHING AND ENSURE THAT NO OBJECTS FILLED WITH LIQUIDS, SUCH AS VASES, ARE PLACED ON THE EQUIPMENT

WARNING:

TO COMPLETELY DISCONNECT THIS EQUIPMENT FROM THE AC MAINS, DISCONNECT THE POWER SUPPLY CORD PLUG FROM THE AC RECEPTACLE

WARNING:

THE MAINS PLUG OF THE POWER SUPPLY CORD SHALL REMAIN READILY OPERABLE

WARNING



Never look directly into an optical fiber. Irreversible eye damage can occur in a matter of milliseconds.

INFORMATION TO USERS IN EUROPE

NOTE

This equipment with the CE marking complies with both the EMC Directive (2004/108/EC) and the Low Voltage Directive (2006/95/EC) issued by the Commission of the European Community.

Compliance with these directives implies conformity to the following European standards:

- EN60065 Product Safety
- EN55103-1 Electromagnetic Interference Class A (Emission)
- EN55103-2 Electromagnetic Susceptibility (Immunity)

This equipment has been tested and found to comply with the limits for a Class A digital device, pursuant to the European Union EMC directive. These limits are designed to provide reasonable protection against harmful interference when the equipment is operated in a commercial environment. This equipment generates, uses, and can radiate radio frequency energy and, if not installed and used in accordance with the instruction manual, may cause harmful interference to radio communications. Operation of this equipment in a residential area is likely to cause harmful interference in which case the user will be required to correct the interference at his own expense.

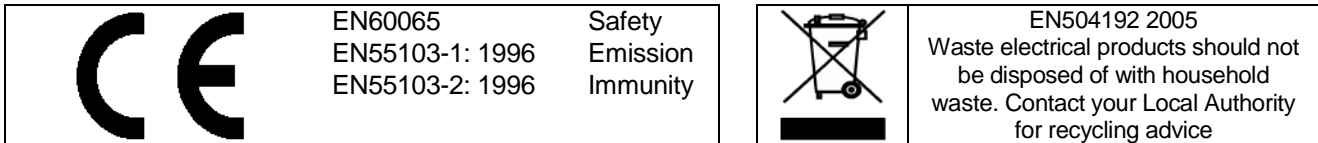

INFORMATION TO USERS IN THE U.S.A.

NOTE

FCC CLASS A DIGITAL DEVICE OR PERIPHERAL

This equipment has been tested and found to comply with the limits for a Class A digital device, pursuant to Part 15 of the FCC Rules. These limits are designed to provide reasonable protection against harmful interference when the equipment is operated in a commercial environment. This equipment generates, uses, and can radiate radio frequency energy and, if not installed and used in accordance with the instruction manual, may cause harmful interference to radio communications. Operation of this equipment in a residential area is likely to cause harmful interference in which case the user will be required to correct the interference at his own expense.

WARNING

Changes or modifications not expressly approved by Evertz Microsystems Ltd. could void the user's authority to operate the equipment. Use of unshielded plugs or cables may cause radiation interference. Properly shielded interface cables with the shield connected to the chassis ground of the device must be used

Evertz Microsystems Ltd  For Commercial Use	Tested to comply with FCC Standards	This device complies with part 15 of the FCC Rules. Operation is subject to the following two conditions: This device may cause harmful interference, and this device must accept any interference received, including interference that may cause undesired operation.
--	-------------------------------------	--

REVISION HISTORY

<u>REVISION</u>	<u>DESCRIPTION</u>	<u>DATE</u>
2.0	Hardware manual for the MVP system	Jan 2005
2.0.1	Change table in section 2.1.8	Mar 2006
2.1	Update to include OE-5/EO-5 and GLINK4 hardware	Mar 2006
2.2	Added Safety Notifications and Servicing Info	May 2006
2.3	Added info on OV-N, PPMX13-4G, and PPMX16-4G hardware Added sections to MVP software chapter, and 3000DCP chapter Added chapter 8 Preset Loads, chapter 9 Setting up Protocols Added chapter 10 Creating Redundant Backups Added chapter 11 Closed Captioning Decode and chapter 12 Fonts	Jul 2006
2.3.1	Changed instructions for configuring GPIs in section 8.2.1	Nov 2006
2.3.2	Updated 3000MVP-OE-5 rear plate diagram	May 2007
2.3.3	Updated section 9.3 to include XY Protocol and ASCII Protocol examples	Jun 2007
2.3.4	Modified GPO's on Figure 2-14	Jan 2008
2.4	Updated Module Specifications	Jan 2008
2.5	Added instructions on configuring the alarms	Apr 2008
2.6	Added 3000MVP-OV-3GHS information (section 3.6)	Oct 2008
2.7	Updated 3000MVP-OV-3G rear plate in section 3.6 ("HS" was removed from the end of the model number)	Jan 2009
2.8	Added 3001 model numbers throughout section 3	Apr 2009
2.8.1	Updated section 3.19	Sept 2009
2.8.2	Updated section 3.17.2 specifications	Oct 2009
2.8.3	Updated fuse safety information	Nov 2009
2.8.4	Updated 3000MVP-AI rear plate photo	Apr 2010
2.8.5	Updated 3000MVP-OV-3G rear plate & added 3001MVP-OV-HS rear plate	Apr 2011
2.8.6	Added information for PPMX16-4H4V card	March 2012

Information contained in this manual is believed to be accurate and reliable. However, Evertz assumes no responsibility for the use thereof, nor for the rights of third parties, which may be affected in any way by the use thereof. Any representations in this document concerning performance of Evertz products are for informational use only and are not warranties of future performance, either expressed or implied. The only warranty offered by Evertz in relation to this product is the Evertz standard limited warranty, stated in the sales contract or order confirmation form.

Although every attempt has been made to accurately describe the features, installation and operation of this product in this manual, no warranty is granted nor liability assumed in relation to any errors or omissions unless specifically undertaken in the Evertz sales contract or order confirmation. Information contained in this manual is periodically updated and changes will be incorporated into subsequent editions. If you encounter an error, please notify Evertz Customer Service department. Evertz reserves the right, without notice or liability, to make changes in equipment design or specifications.

TABLE OF CONTENTS

1. MVP™ QUICK START GUIDE	1-1
1.1. SIMPLE MVP™ CONNECTIVITY	1-2
2. MVP™ SYSTEM OVERVIEW	2-1
2.1. MVP™ FRAME (3000FR).....	2-1
2.2. MVP™ I/O MODULES	2-1
2.2.1. Display Card Resolution Support	2-3
2.2.2. Display Card Output Support	2-3
2.2.3. MVP Cabling Recommended Lengths	2-3
2.3. INSTALLING AND REMOVING THE MODULES.....	2-4
2.3.1. Installing the Module Rear Plate	2-4
2.3.2. Opening and Closing the Front Panel	2-4
2.3.3. Installing a Module	2-4
2.3.4. Removing a Module	2-5
2.4. MOUNTING	2-5
2.5. COOLING	2-5
2.5.1. Fan Exhaust.....	2-5
2.6. SERVICING INSTRUCTIONS.....	2-6
2.6.1. Changing the Fuses.....	2-6
2.6.2. Replacing the Power Supply	2-6
2.7. POWER	2-9
2.7.1. Connecting the Power.....	2-9
2.7.2. Turning the Power On and Off	2-10
2.7.3. Power Supply Status Indicators	2-10
2.8. FRAME STATUS FAULT CONDITIONS	2-11
2.8.1. Frame Status Tally Terminal Block.....	2-12
2.9. CARE AND HANDLING OF OPTICAL FIBER	2-12
2.9.1. Safety	2-12
2.9.2. Assembly	2-12
2.9.3. Labeling	2-12
2.9.4. Handling and Connecting Fibers	2-13
3. SPECIFICATIONS	3-1
3.1. 3000FR FRAME SPECIFICATIONS.....	3-1
3.1.1. Genlock.....	3-1
3.1.2. Electrical	3-1

3.1.3. Compliance.....	3-1
3.1.4. Physical	3-1
3.2. 3000FC FRAME CONTROLLER MODULE.....	3-2
3.2.1. Specifications.....	3-2
3.2.1.1. Ethernet	3-2
3.2.1.2. Serial Communications	3-2
3.2.1.3. Electrical	3-2
3.3. 3000/3001MVP-OV-N	3-3
3.3.1. Specifications.....	3-3
3.3.1.1. Video.....	3-3
3.3.1.2. Electrical	3-3
3.3.1.3. Physical.....	3-3
3.3.2. Ordering Information	3-3
3.4. 3000/3001MVP-OV-SNX	3-4
3.4.1. Specifications.....	3-4
3.4.1.1. Video.....	3-4
3.4.1.2. Electrical	3-4
3.4.1.3. Physical.....	3-4
3.4.2. Ordering Information	3-4
3.5. 3000MVP-OV-HSN	3-5
3.5.1. Specifications.....	3-5
3.5.1.1. Video.....	3-5
3.5.1.2. Electrical	3-5
3.5.1.3. Physical.....	3-5
3.5.2. Ordering Information	3-6
3.6. 3000MVP-OV-3G & 3001MVP-OV-HS	3-8
3.6.1. Specifications.....	3-8
3.6.1.1. Video.....	3-8
3.6.1.2. Electrical	3-8
3.6.1.3. Physical.....	3-8
3.6.2. Ordering Information	3-8
3.7. 3000MVP-GI-2, 3001MVP-GI-2-ED AND 3000MVP-GI-4, 3001MVP-GI-4-ED.....	3-9
3.7.1. Specifications.....	3-9
3.7.1.1. Graphics Inputs	3-9
3.7.1.2. Outputs	3-10
3.7.1.3. Electrical	3-10
3.7.1.4. Physical.....	3-10
3.7.2. Ordering Information	3-10
3.8. 3000MVP-AI AND 3000MVP-AI-AESU	3-11
3.8.1. Specifications.....	3-11
3.8.1.1. Audio Inputs	3-11
3.8.1.2. Electrical:	3-11
3.8.1.3. Physical.....	3-11
3.8.2. Ordering Information	3-11
3.8.2.1. 3000MVP-AI BHP Combinations and Ordering Information:.....	3-12

3.8.2.2.	3000MVP-AI SCSI Pin-out Detail (AES or Analog Audio)	3-12
3.9.	3000MVP-PPV-9 AND 3000MVP-PPV-9+D.....	3-13
3.9.1.	Specifications.....	3-13
3.9.1.1.	Video Inputs	3-13
3.9.1.2.	Video Output	3-13
3.9.1.3.	Auxiliary Outputs	3-14
3.9.1.4.	Electrical	3-14
3.9.1.5.	Physical.....	3-14
3.9.2.	Ordering Information	3-14
3.10.	3000MVP-PPMV13.....	3-16
3.10.1.	Specifications.....	3-16
3.10.1.1.	Video Input.....	3-16
3.10.1.2.	HD SDI Outputs.....	3-16
3.10.1.3.	DVI Outputs.....	3-16
3.10.1.4.	Optical Outputs	3-17
3.10.1.5.	Auxiliary Outputs	3-17
3.10.1.6.	Electrical Specification.....	3-17
3.10.1.7.	Physical.....	3-17
3.10.2.	Ordering Information	3-17
3.11.	3000MVP-PPMX16-4G, 3000MVP-PPMX16-4H4G & 3000MVP-PPMX16-4H4V	3-19
3.11.1.	Specifications.....	3-19
3.11.1.1.	Video Input.....	3-19
3.11.1.2.	GLINK Outputs.....	3-20
3.11.1.3.	Optical Outputs	3-20
3.11.1.4.	HD SDI Outputs.....	3-20
3.11.1.5.	Auxiliary Outputs	3-20
3.11.1.6.	DVI Outputs.....	3-20
3.11.1.7.	Electrical Specification.....	3-21
3.11.1.8.	Physical.....	3-21
3.11.2.	Ordering Information	3-21
3.12.	3000MVP-PPMX16-8G AND 3000MVP-PPMX16-8GC	3-23
3.12.1.	Specifications.....	3-23
3.12.1.1.	Video Input.....	3-23
3.12.1.2.	GLINK Outputs.....	3-23
3.12.1.3.	Optical Outputs	3-23
3.12.1.4.	Auxiliary Outputs	3-24
3.12.1.5.	Electrical Specification.....	3-24
3.12.1.6.	Physical.....	3-24
3.13.	3000MVP-PPR-16X16	3-26
3.13.1.	Specifications.....	3-26
3.13.1.1.	Video Input.....	3-26
3.13.1.2.	Video Output	3-26
3.13.1.3.	Electrical	3-26
3.13.1.4.	Physical.....	3-26
3.13.2.	Ordering Information	3-26
3.14.	3000MVP-GLINK4.....	3-27

3.14.1. Specifications.....	3-27
3.14.1.1. Video Inputs.....	3-27
3.14.1.2. Video Outputs.....	3-27
3.14.1.3. Electrical.....	3-27
3.14.1.4. Physical.....	3-27
3.14.2. Ordering Information.....	3-27
3.15. 3000MVP-OE-5 AND 3000MVP-EO-5.....	3-28
3.15.1. 3000MVP-EO-5 I/O Specifications.....	3-28
3.15.1.1. Video Input.....	3-28
3.15.1.2. Video Output.....	3-28
3.15.2. 3000MVP-OE-5 I/O Specifications.....	3-28
3.15.2.1. Video Input.....	3-28
3.15.2.2. Video Output.....	3-29
3.15.3. Electrical.....	3-29
3.15.4. Ordering Information.....	3-29
3.16. 3000DCP.....	3-30
3.16.1. Specifications:.....	3-30
3.16.1.1. Physical.....	3-30
3.16.1.2. Operational.....	3-30
3.16.1.3. Communications.....	3-30
3.16.1.4. Electrical.....	3-30
3.17. GENERAL PURPOSE INPUTS AND OUTPUTS (VIA DISPLAY MODULES).....	3-31
3.18. SERIAL INTERFACE (VIA OUTPUT MODULES).....	3-32
3.18.1. RS-232 Mode.....	3-32
3.18.2. RS-422 Mode.....	3-33
3.19. 3000MVP-PPV-X SCSI A AND SCSI B PIN ASSIGNMENT TABLE.....	3-34
3.20. MVP™ BREAK-OUT I/O PANELS.....	3-34
3.20.1. 3000BHP-U (Option Included with AI modules - Identified as 3000MVP-AI+BHPU).....	3-35
3.20.2. 3000BHP-BAL (Option Included with AI Modules - Identified as 3000MVP-AI+BHPBAL).....	3-35
3.20.3. WP3000BHPDVIO CABLE (PPV9+D, PPMV).....	3-35
3.20.4. 3000BHP-AUX (Included with all PPV and PPMV Display Card Modules).....	3-36
3.20.5. 3000MKT-AUX Breakout Panel Mounting Kit.....	3-38
4. MVP™ NETWORK CONFIGURATION.....	4-1
4.1.1. Part 1: Making the Network Connections.....	4-1
4.1.2. Part 2: Connecting Serial Communications to the MVP Modules.....	4-3
4.1.3. Part 3: Terminal Program Setup.....	4-3
4.1.4. Part 4: Setting IP Addresses on MVP Modules.....	4-4
4.1.4.1. Set the IP Address and Configure the “PPV” or “PPMx” Module.....	4-5
4.1.4.2. Set the IP Address and Configure the “OV” and/or “GI” Module.....	4-8
5. MAPPING DISCRETE AUDIO TO VIDEO INPUTS.....	5-1
5.1. AUDIO MENU ITEMS.....	5-4

6.	MODULE UPGRADES	6-1
6.1.	NETWORKING FUNDAMENTALS (FTP UPGRADE PROCESS).....	6-1
6.2.	UPGRADING THE APPLICATION CODE.....	6-1
6.2.1.	VIDEO I/O FTP Upgrade Method.....	6-2
6.2.2.	VIDEO I/O Serial Upload Method.....	6-4
6.2.3.	Upgrading 3000FC Application Code.....	6-5
6.2.4.	Upgrading 3000MVP-AI, 3000MVP-VGO, 3000MVP-GO, 3000MVP-PPR Application Code.....	6-6
7.	MVP™ SOFTWARE	7-1
7.1.	PC MINIMUM REQUIREMENTS	7-1
7.2.	INSTALLING SOFTWARE	7-1
7.3.	CONFIGURING A SYSTEM	7-2
7.4.	ENABLING THE MVP EMBEDDED SERVER.....	7-3
7.5.	CONFIGURING AN EMBEDDED SERVER MVP	7-6
7.6.	ADDING A SYSTEM TO MAESTRO SOFTWARE.....	7-9
7.7.	CONNECTING TO THE SYSTEM	7-11
7.8.	MVP UPGRADE	7-12
7.9.	CONFIGURING THE ALARMS	7-13
7.9.1.	Configuration of Alarms in Maestro.....	7-13
7.9.2.	Adjusting Parameters for Alarms in VLPro – C.....	7-17
7.9.3.	Configuring the Traps.....	7-19
8.	CONFIGURING THE 3000DCP DESKTOP CONTROL PANEL.....	8-1
8.1.	FOR SYSTEMS USING ONBOARD SERVER	8-1
8.1.1.	Creating the System and Setting up the Hardware.....	8-1
8.1.2.	Enabling the DCP Server	8-3
8.2.	FOR SYSTEMS USING PC SERVER.....	8-4
8.3.	FOR PC AND ONBOARD SERVER – DCP SETUP.....	8-5
8.4.	UPGRADING THE 3000DCP.....	8-6
9.	SETTING UP PRESET LOADS	9-1
9.1.	SETTING UP A GPI PRESET LOAD – OFFBOARD SERVER	9-1
9.1.1.	The gpicfg.vssl File	9-1
9.1.2.	The actions.vssl File.....	9-2
9.1.3.	How to Set Up a GPI Preset Load (Offboard Server)	9-2

9.2.	SETTING UP A GPI PRESET LOAD - ONBOARD SERVER.....	9-9
9.2.1.	The gpicfg.vssl File	9-10
9.2.2.	The actions.vssl File	9-10
9.2.3.	How to Set Up a GPI Preset Load.....	9-11
9.3.	SETTING UP A VGPI PRESET LOAD – OFFBOARD SERVER.....	9-19
9.3.1.	The gpicfg.vssl File	9-19
9.3.2.	The actions.vssl File	9-20
9.3.3.	How to Set Up a VGPI Preset Load	9-20
9.4.	SETTING UP A VGPI PRESET LOAD – ONBOARD SERVER.....	9-28
9.4.1.	The gpicfg.vssl File	9-29
9.4.2.	The actions.vssl File	9-29
9.4.3.	How to Set Up a VGPI Preset Load	9-30
10.	SETTING UP PROTOCOLS	10-1
10.1.	SETTING UP MVP TO WORK WITH IMAGE VIDEO PROTOCOL	10-1
10.2.	SETTING UP MVP TO WORK WITH TSL PROTOCOL.....	10-2
10.3.	SETTING UP MVP TO WORK WITH X-Y PROTOCOL.....	10-4
10.3.1.	Creating the Text Files.....	10-4
10.3.2.	Setting Up the Display Card(s).....	10-5
10.4.	SETTING UP MVP TO WORK WITH ASCII PROTOCOL	10-7
10.4.1.	Creating the Text File.....	10-7
10.4.2.	Setting Up the Display Card(s).....	10-7
11.	CREATING A REDUNDANT BACKUP OF AN OUTPUT CARD.....	11-1
12.	ENABLING CLOSED CAPTIONING DECODE	12-1
12.1.	PART 1: CHANGING THE SERVER SETTINGS	12-1
12.2.	PART 2: CONFIGURING THE CLOSED CAPTIONING PROPERTIES	12-3
12.2.1.	608 Closed Captioning Decode.....	12-3
12.2.2.	708 Closed Caption Decode	12-4
12.2.3.	Teletext.....	12-5
12.3.	PART 3: SENDING THE SETTINGS TO THE SERVER.....	12-5
12.4.	PART 4: STARTING MAESTRO AND ENABLING CLOSED CAPTIONING DECODE	12-6
13.	CONFIGURING FONTS.....	13-1

FIGURES

Figure 2-1: Locating the Power Supply Mounting Screw	2-8
Figure 2-2: Connecting the Power to the 3000FR	2-9
Figure 2-3: 3000PS Status Indicators	2-10
Figure 2-4: Reproduction of Laser Certification and Identification Label	2-13
Figure 3-1: 3000MVP-OV-HSN and 3000MVP-GI Card LED Assignment	3-7
Figure 3-2: 3000MVP-PPV-9 card LED assignment.....	3-15
Figure 3-3: GPI Input Circuitry	3-31
Figure 3-4: GPO Output Circuitry.....	3-31
Figure 3-5: Interfacing GPIs to a High Voltage GPI System.....	3-32
Figure 3-6: WP3000BHPDVIO Breakout Cable.....	3-35
Figure 3-7: Top View.....	3-36
Figure 3-8: Bottom View (to PPV-x Module via SCSI Cable, Factory-Provided).....	3-36
Figure 3-9: AES, LTC and Serial Data Ports (Connected to PPV-x Module SCSI A)	3-37
Figure 3-10: GPIO Connections when Connected to PPV-x Module SCSI A	3-37
Figure 3-11: GPIO Connections when Connected to PPV-x Module SCSI B	3-38
Figure 3-12: Mounting Breakout Panels Using the 3000MKT-AUX Breakout Panel Mounting Kit.....	3-38
Figure 4-1: Making the Ethernet Connection	4-1
Figure 5-1: Audio Setup Window	5-3
Figure 6-1: Run Window	6-3
Figure 7-1: System Manager and Maestro Desktop Icons	7-1
Figure 7-2: Unlocking the Server	7-2
Figure 7-3: System Connection Status Window	7-3
Figure 7-4: Main Menu	7-4
Figure 7-5: Onboard Server Configuration Menu	7-5
Figure 7-6: Connection Status	7-6
Figure 7-7: Entering the Display Card's IP Address	7-6
Figure 7-8: System Configuration Screen.....	7-7
Figure 7-9: Entering Hardware Components	7-8
Figure 7-10: PLINK Setup Screen	7-9
Figure 7-11: MVP Maestro Icon	7-9
Figure 7-12: Add System Form.....	7-10
Figure 7-13: System Icon.....	7-10
Figure 7-14: Display Icons	7-11
Figure 7-15: Connect Button.....	7-11
Figure 7-16: System Configuration and Maestro Icons	7-13
Figure 7-17: Maestro System Manager	7-13
Figure 7-18: Maestro Display Manager.....	7-14
Figure 7-19: 4x3 Display	7-14
Figure 7-20: Object on Design Canvas.....	7-15
Figure 7-21: Maestro Fault Display.....	7-16
Figure 7-22: Defining Trigger for Video.....	7-16
Figure 7-23: VistaLINK® Navigation Tree	7-17
Figure 7-24: Audio Control Tab.....	7-18
Figure 7-25: Video Fault Definitions Tab	7-19
Figure 7-26: SNMP Configuration.....	7-20
Figure 8-1: Adding DCP to Hardware List.....	8-2
Figure 8-2: Transfer Scripts Window	8-3
Figure 8-3: Onboard Server Configuration Menu	8-3
Figure 8-4: Adding the DCP to the Hardware List	8-4
Figure 8-5: Transfer Scripts Window	8-5
Figure 9-1: Open With Window	9-3
Figure 9-2: Word Wrap.....	9-3
Figure 9-3: Save As	9-4

Figure 9-4: Open With.....	9-4
Figure 9-5: Word Wrap	9-5
Figure 9-6: Save As	9-5
Figure 9-7: MVP System Manager	9-6
Figure 9-8: Transfer Scripts	9-6
Figure 9-9: Transfer Scripts	9-7
Figure 9-10: Transfer Scripts	9-7
Figure 9-11: MVP System Manager	9-8
Figure 9-12: Global Settings	9-9
Figure 9-13: Main Menu.....	9-17
Figure 9-14: Onboard Server Configuration Menu	9-18
Figure 10-1: Auxiliary Port Setup Menu.....	10-1
Figure 10-2: Under Monitor Display Setup	10-2
Figure 10-3: Auxiliary Serial Port Settings	10-3
Figure 10-4: Under Monitor Display Setup Settings	10-3
Figure 10-5: Sample Text Files.....	10-5
Figure 10-6: Auxiliary Serial Port Setup.....	10-6
Figure 10-7: Setting up XY Integrator Protocol Operation.....	10-6
Figure 10-8: Command Displayed on the Output Display	10-7
Figure 10-9: Auxiliary Serial Port Setup Menu.....	10-8
Figure 10-10: Under Monitor Display Setup Menu	10-8
Figure 12-1: Onboard Server IP Address	12-1
Figure 12-2: Hardware Settings.....	12-2
Figure 12-3: Properties	12-2
Figure 12-4: 608 Properties	12-3
Figure 12-5: 708 Properties	12-4
Figure 12-6: Teletext Properties	12-5
Figure 12-7: System Manager	12-7
Figure 12-8: Display Manager.....	12-8
Figure 12-9: Properties > Appearance	12-9

TABLES

Table 2-1: Frame Status Tally Terminal Block Pin Assignments.....	2-12
Table 4-1: Standard RJ45 Wiring Colour Codes	4-2
Table 4-2: 7700PB Upgrade Cable (WA-S76).....	4-3

1. MVP™ QUICK START GUIDE

This section describes how to quickly start using a standard MVP™ system. Further details, specifications, and instructions on the MVP™ and Maestro™ are provided herein.

1

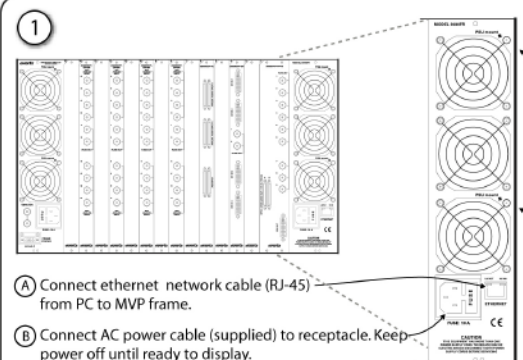

A Connect ethernet network cable (RJ-45) from PC to MVP frame.

B Connect AC power cable (supplied) to receptacle. Keep power off until ready to display.

(To remove power supply from the frame, remove the PS mount screws from the back of the power supply unit.)

2

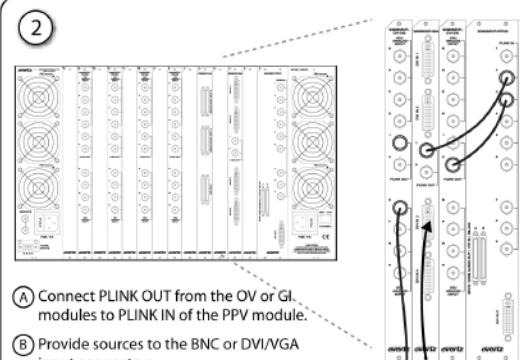

A Connect PLINK OUT from the OV or GI modules to PLINK IN of the PPV module.

B Provide sources to the BNC or DVI/VGA input connectors.

3

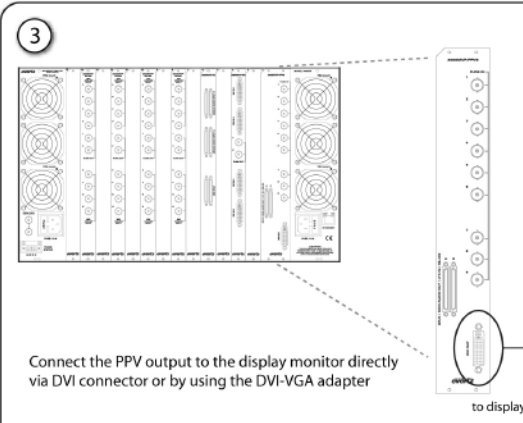

Connect the PPV output to the display monitor directly via DVI connector or by using the DVI-VGA adapter to display

4

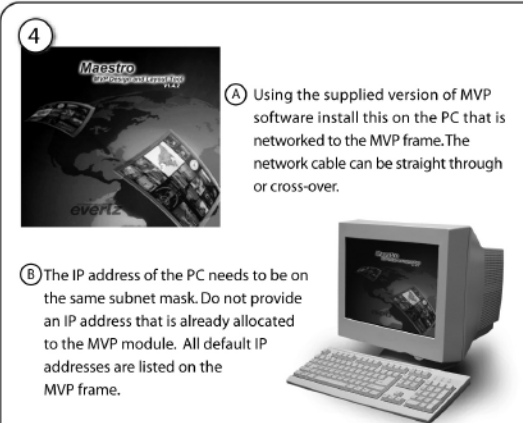

A Using the supplied version of MVP software install this on the PC that is networked to the MVP frame. The network cable can be straight through or cross-over.

B The IP address of the PC needs to be on the same subnet mask. Do not provide an IP address that is already allocated to the MVP module. All default IP addresses are listed on the MVP frame.

5

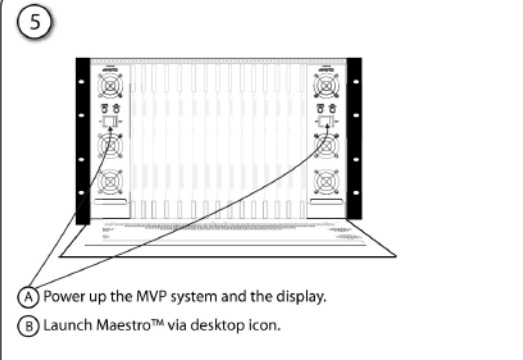

A Power up the MVP system and the display.

B Launch Maestro™ via desktop icon.

6

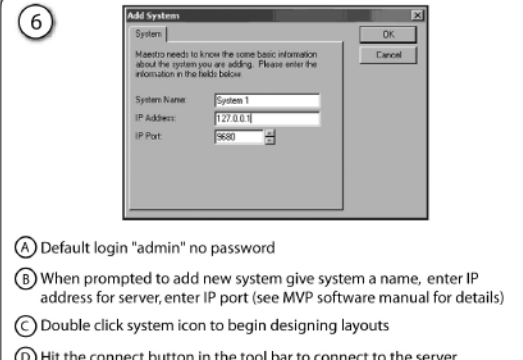

A Default login "admin" no password

B When prompted to add new system give system a name, enter IP address for server, enter IP port (see MVP software manual for details)

C Double click system icon to begin designing layouts

D Hit the connect button in the tool bar to connect to the server

E See MVP software manual for further details on using Maestro™ software.

1.1. SIMPLE MVP™ CONNECTIVITY

The previous block diagram shows a simple connection between video inputs to an OV module, and its PLINK output to a display processor (“PPV”) module, and eventually to a monitor/display. Inputs A through H for both input modules are provided via coax cable with BNC connectors directly to the rear plates. PLINK OUT BNCs from these input module rear plates are connected using (at minimum) Belden 1694A cable to the PLINK IN input BNCs of the PPV module.

The output of the PPV can be a straight-through DVI cable connected directly to the display. The DVI output of the 3000MVP-PPV-9 output processor module is a DVI-I standard, providing one DVI output simultaneously with one RGBHV output signal (both carry the same video display content information and cannot be independently configured).

PLINK 1 or 2 from the OV card can be used to connect to the display cards in the MVP system. It is standard to use the first PLINK output of the input card to connect to the first display card in the system. If there is a second display card in the system, then the second PLINK output from the OV card can be used to provide video via PLINK .

Simple MVP systems that consist of two or fewer display modules, and fewer than 13 input modules with no PLINK packet router present are configured at the factory with an on-board server. In these systems, the user is only required to open the Maestro GUI client and enter the IP address of the display card that is running said “on board” server. This will provide them with complete control of the MVP system for the purpose of defining layouts. For more complex MVP systems that do not meet the criteria mentioned above, the PC-based sever must be configured on a PC and launched before proceeding to the Maestro software for layout design. More details are described later in this manual regarding the use of the system configuration tools and system manager.

2. MVP™ SYSTEM OVERVIEW

2.1. MVP™ FRAME (3000FR)

The MVP™ multi-image display processor is housed in a 6RU, rack-mountable frame (3000FR). Each frame can accommodate up to two (2) hot-swappable power supply units (3000PS) and up to fifteen (15) single slot, hot-swappable I/O modules. Each module has a corresponding, passive rear plate, which is mounted via three (3) screws to the frame. It is important that all three screws are used to fasten the rear plates to ensure proper connectivity with the I/O modules.

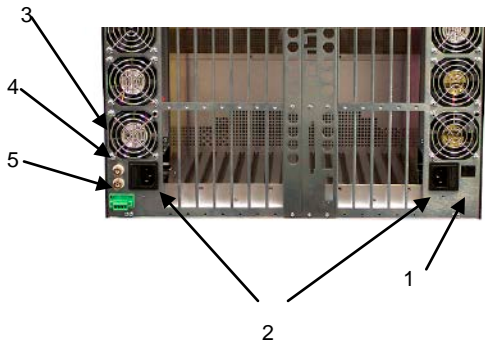

The MVP™ frame is also equipped with a frame controller unit used for facilitating network communications between the frame modules and the MVP Maestro™ configuration software. The frame controller module (3000FC) is located under the left power supply unit, when looking directly at the front of the 3000FR frame. The network receptacle (RJ-45) is accessed on the back of the frame (see #1 on diagram).

Each of the two power supplies is equipped with a separate power line cord, and provides PSU status information via LEDs on the front panel.

The rear side of the 3000FR frame is also equipped with the following connections:

3. NTSC Genlock via BNC
4. PAL Genlock via BNC
5. GROC Connector

2.2. MVP™ I/O MODULES

The MVP™ system is built from a variety of input and output modules. All modules are hot-swappable and can reside in any one of the 15 slots of the 3000FR frame. Available I/O modules include:

3000MVP-OV-N	Octal NTSC/PAL input module
3000MVP-OV-SNX	Auto detect, octal SD and NTSC/PAL input module (with embedded audio support), with extended data service decoding capability
3000MVP-OV-HSN	Auto detect, octal, HD, SD and NTSC/PAL input module (with embedded audio support)
3000MVP-GI-4	Quad graphics input module (up to UXGA)

3000MVP-GI-2	Dual graphics input module (up to UXGA).
3000MVP-AI	Analog and AES/EBU audio input module.
3000MVP-PPV-9	Video output processor and display module provides a single DVI-I output to UXGA (1600x1200) resolution display.
3000MVP-PPV-9+D	Dual video output processor and display module provides two unique DVI outputs (and 1 duplicated RGBHV) to two separate SXGA+ (1400 x 1050) resolution displays.
3000MVP-PPMV13	Identical to the PPMV display card with four additional PLINK inputs, providing a total of 13 PLINK inputs, supporting up to 104 videos
3000MVP-PPMX16-4G	High-resolution multi-output display processor module, provides up to four unique GLINK outputs via coax or fiber at UXGA resolution on all four outputs, with 16 PLINK inputs allowing up to 128 unique video windows in standard PLINK fan configurations.
3000MVP-PPMX16-4H4G	High-resolution multi-output display processor module, provides up to 4 unique GLINK outputs via fiber and 4 HD-SDI outputs at up to WUXGA resolution on all 4 outputs. 16 PLINK inputs allowing up to 128 unique video windows in standard PLINK fan configurations.
3000MVP-PPMX16-8G	High-resolution multi-output display processor module, provides up to 8 unique GLINK outputs via fiber at up to 1920x1080p resolution on all 8 outputs. 16 PLINK inputs allowing up to 128 unique video windows in standard PLINK fan configurations.
3000MVP-PPMX16-8GC	High-resolution multi-output display processor module, provides up to 8 unique GLINK outputs via coax at up to 1920x1080p resolution on all 8 outputs. 16 PLINK inputs allowing up to 128 unique video windows in standard PLINK fan configurations.
3000MVP-PPR-16x16	PLINK packet router providing a total of 16 PLINK inputs to 16 PLINK outputs.
3000MVP-GLINK4	Quad GLINK input card.
3000MVP-EO/OE-5	Electrical to optical and optical to electrical converter.

3000DCP Desktop control panel.

Detailed module descriptions, module rear plate drawings, and specifications are provided in sections 3.3 to 3.18.

Due to constant research and development, specifications are subject to change without notice. For the latest specification information, please visit www.evertz.com or contact your Evertz representative.

2.2.1. Display Card Resolution Support

	XGA	WXGA	Alternate WXGA	SXGA	SXGA+	UXGA	WUXGA	720p	1080i (HD-SDI Output only)	1080p	525i (SD-SDI Output only)	625i (SD-SDI Output only)
3000MVP-PPV9	x	x	x	x	x	x		x		x		
3000MVP-PPV9+D	x	x	x	x	x			x				
3000MVP-PPMV13	x	x	x	x	x	x*		x	x	x*	x	x
3000MVP-PPMV+G	x	x	x	x	x	x*		x	x	x*	x	x
3000MVP-PPMX16-4G	x	x	x	x	x	x	x	x		x		
3000MVP-PPMX16-4H4G	x	x	x	x	x	x	x	x	x	x	x	x
3000MVP-PPMX16-8G	x	x	x	x	x	x	x	x		x		
3000MVP-PPMX16-8GC	x	x	x	x	x	x	x	x		x		

* Note: only two of 4 outputs active at this resolution

2.2.2. Display Card Output Support

	# VGA	# DVI	# GLINK fiber	# GLINK coax	# HD/SD-SDI
3000MVP-PPV9	1	1	0	0	0
3000MVP-PPV9+D	0	2	0	0	0
3000MVP-PPMV13	0	4	0	0	4
3000MVP-PPMV+G	0	4	4	0	4
3000MVP-PPMX16-4G	0	0	4	4	0
3000MVP-PPMX16-4H4G	0	0	4	0	4
3000MVP-PPMX16-8G	0	0	8	0	0
3000MVP-PPMX16-8GC	0	0	0	8	0

2.2.3. MVP Cabling Recommended Lengths

- PLINK (coax) max length = 20 meters, 65 feet
- 2430GDAC GLINK (coax) max length = 10 meters, 33 feet
- 2430GDAC GLINK (fiber) multi-mode max length = 100 meters, 330 feet
- 2430GDAC GLINK (fiber) single-mode max power budget = 16dBm (10Km of cable under ideal conditions)
- HD-SDI input (coax) max length = 100m, 330 feet
- SD-SDI input (coax) max length = 250m, 820 feet

- DVI digital max length = 3 meters, 10 feet¹
- VGA analog max length = 5 meters, 15 feet¹

¹ Please make note that limitations are based on ideal cabling conditions, as well as ideal receivers/displays.

2.3. INSTALLING AND REMOVING THE MODULES

2.3.1. Installing the Module Rear Plate

In most cases, the MVP™ frame will already have the module and rear plate installed within the frame. However, when modules and rear plates need re-positioning, or when additional modules are purchased, proper module/rear plate installation is required.

Each MVP™ module is shipped with a matching rear panel plate that houses the appropriate connectors for that module.

To install the MVP™ Rear Plate:

1. Locate the specific slot in the frame and remove any filler plates.
2. Install the rear plate over the open slot by first fitting the plate then tightening the two lock-screws.
3. Fasten the third screw in the middle of the rear plate.
4. Tighten the screws after the main module is installed.



CAUTION: If any of the screws for the rear plate are missing, please contact Evertz immediately for the specification and/or replacement. Using the incorrect screw can cause thread stripping.

2.3.2. Opening and Closing the Front Panel

In order to insert or remove modules you will have to open the front panel using the following procedure:

1. Turn the two captive screws located on the front panel counter clockwise several turns until they release completely from the front extrusions.
2. Carefully lower the front panel door so that the front edge of the door is lower than the rear of the door.

2.3.3. Installing a Module

1. Orient the module vertically such that the smaller white card ejector is on the bottom, while the larger white/beige card ejector is on the top.
2. Align the card with the card guide corresponding to the slot number where you installed the rear panel plate.

3. Carefully slide the module into the frame and press it completely into the rear panel connectors.
4. Use the upper card-ejector to latch the module into the slot.
5. Make sure that the connectors are fully seated in the rear panel.
6. When this is done, close the front panel and then tighten the screws that hold the rear panel in place.

2.3.4. Removing a Module

1. Press the card ejector down to release the module.
2. Grasp the card using the upper card ejector and pull the module out from the frame.
3. Carefully place the module in a safe place, free from static discharge.

2.4. MOUNTING

The MVP™ frame is equipped with rack mounting rails and fits into a standard 19" x 10.5" x 14.5" rack space (483 mm x 260 mm x 368 mm). To securely fasten the frame to the equipment rack, make sure that all four mounting screws on each mounting rail are tightened securely.

After the unit has been installed in a rack, all cards in the frame should be checked to ensure they are fully seated within the frame. This is best accomplished by simply pushing (simultaneously, with moderate force) on each card's top and bottom insertion/extraction levers. See section 2.3.3 for further information. This step should be repeated any time the frame is shipped, or relocated within a facility.

2.5. COOLING

The MVP™ frame is designed to ensure adequate cooling for up to 600 watts of processing power per frame. Fans at the front and rear of each power supply module accomplish forced air-cooling. Adjacent equipment may be mounted immediately to the top and bottom of the frame. Additional module cooling is provided by interior cooling channels to ensure that even fully loaded frames mounted adjacent to each other will operate within the normal temperature range.



CAUTION: For proper cooling, the frame must contain either two 3000PS power supplies, or one 3000PS power supply and one 3000PS-FM power supply blank panel with cooling fan.

2.5.1. Fan Exhaust

The cooling fans for the power supplies, located at the front of the frame, draw air in the front and exhaust out the sides of the frame. The cooling fans for the modules, located at the rear of the frame, draw air in the front and the exhaust out the rear of the frame.



CAUTION: To ensure adequate cooling, care should be taken to ensure that the fan inlets and exhaust openings are free of obstructions.

2.6. SERVICING INSTRUCTIONS



CAUTION: These servicing instructions are for use by qualified service personnel only. To reduce the risk of electric shock, do not perform any servicing instructions in this section of the manual unless you are qualified to do so.

2.6.1. Changing the Fuses



CAUTION: For continued protection against the risk of fire, replace only with the same type and rating of fuse.

ATTENTION: Pour éviter les risques d'incendie, remplacer le fusible avec un fusible de même calibre.

The fuse holder is located inside the power entry module. To change the fuses, disconnect the line cord from the power entry module and pull the fuse holder out from the power entry module using a small screwdriver. The fuse holder contains two fuses, one for the line and one for the neutral side of the mains connection. Pull out the blown fuse and place a fuse of the correct value in its place.

For 100-120 VAC operation, use ceramic time delay 5 x 20 mm fuses rated for 250 Volts with a 10 amps current rating. For 220-240 VAC operation use ceramic time delay 5 x 20 mm fuses rated for 250 Volts with a 6.3 amps current rating.

For your convenience there are spare fuses located in the vinyl pouch in the front of this manual. Carefully reinsert the fuse holder into the power entry module.

2.6.2. Replacing the Power Supply

Each power supply is a complete assembly, and includes the power supply cooling fan and one frame-cooling fan. In the event that the power supply or one of the fans malfunction, you will need to replace the power supply assembly with a spare one while the failed assembly is being repaired.



CAUTION: Do not run the frame for extended periods of time with one of the power supplies removed. Proper cooling of the frame requires both power supplies to be inserted into the frame, or one power supply and a 3000PS-FM power supply blank panel.

The 3000PS power supplies are hot swappable and can be easily replaced from the front without interrupting the signal integrity of the frame. Each power supply is capable of supplying full power to the frame by itself, however we recommend running with both supplies powered for power redundancy. On frames with only one power supply, a 3000PS-FM blank power supply module with cooling fan **must** be inserted into the second power supply space. The 3000PS-FM contains a module-cooling fan and baffles to maintain proper airflow within the frame.

The power supply is secured into the frame by two machine screws through the rear panel (as shown in Figure 2-1). These screws must be removed before the power supply can be extracted from the front.

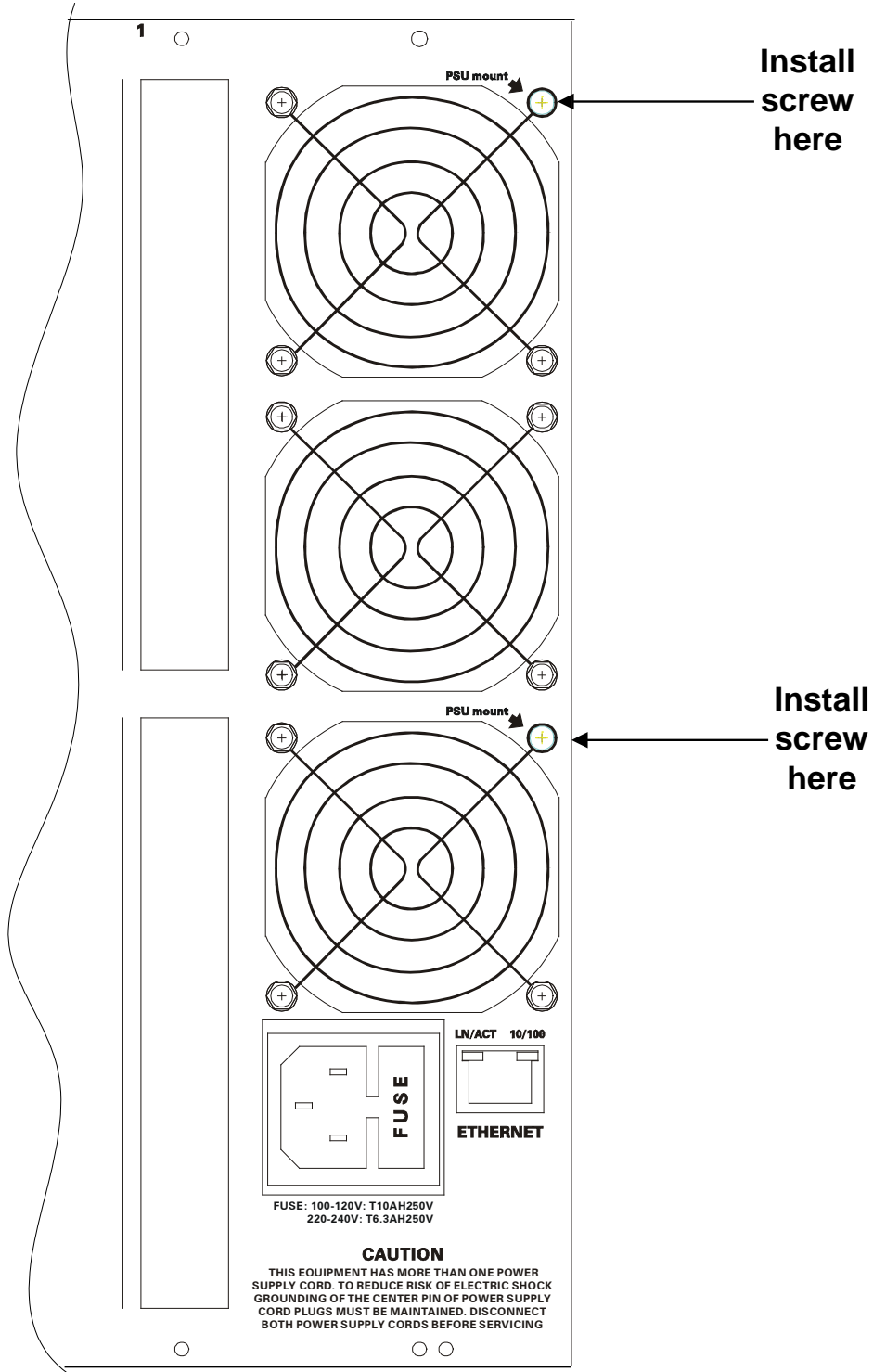

Figure 2-1: Locating the Power Supply Mounting Screw



CAUTION: To reduce the risk of electric shock, you must replace the mounting screw *after* replacing the power supply.

2.7. POWER

The power entry modules contain a standard IEC power inlet connector, two 5 x 20 mm fuse holders, and an EMI line filter.



CAUTION: The 3000FR is shipped with 10 Amp fuses rated for 100-120 VAC operation. If you are operating the MVP System in a country with nominal 220-240 VAC operation, replace the fuses with 6.3 Amp fuses rated for 220-240 VAC operation. See section 2.6.1 for information on changing fuses.

2.7.1. Connecting the Power

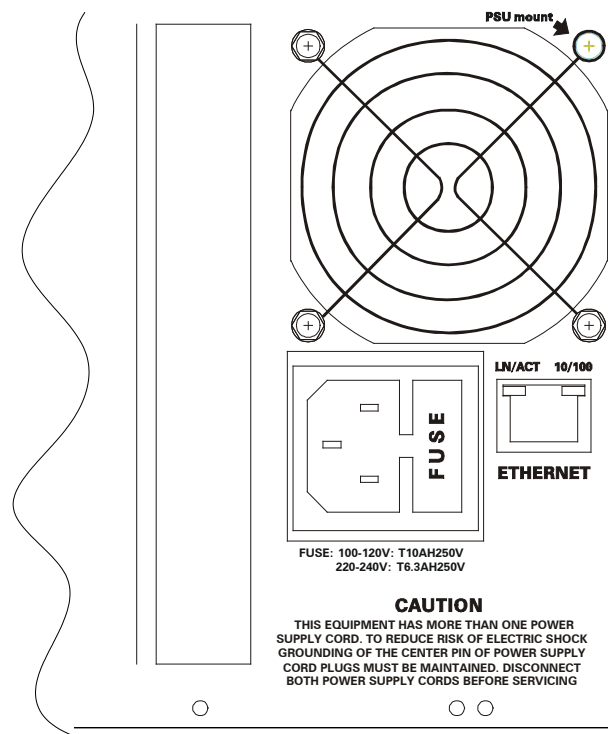

Figure 2-2: Connecting the Power to the 3000FR

The 3000FR frame comes standard with one auto-ranging power supply (3000PS) that automatically senses the input voltage over the range of 100 to 240 VAC. An additional power supply can be ordered to provide fully redundant powering of the frame. When only one power supply is fitted, the frame will be fitted with a 3000PS-FM fan module to ensure the thermal integrity of the frame cooling. In a frame that contains a redundant power supply module, each power supply may be powered from a different AC mains source, allowing complete AC supply redundancy.

Power should be applied by connecting a three-wire, grounding-type power supply cord to the power entry module on the rear panel of each power supply. For use in North America, the power cord should be a minimum 18 AWG wire size; type SVT marked VW-1, maximum 2.5 m in length. For use outside North America, use a power cord approved for the country of use with a minimum 1.00 mm² wire size.



CAUTION: To reduce the risk of electric shock, grounding of the ground pin of the main plug must be maintained.

2.7.2. Turning the Power On and Off

Each power supply is fitted with its own power switch. When the switch is turned off, the remaining power supply will power the frame. To completely remove power from the frame, both power supplies must be turned off.

2.7.3. Power Supply Status Indicators

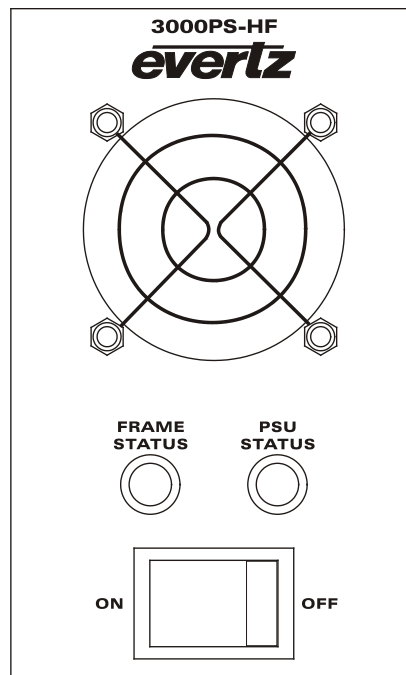

Figure 2-3: 3000PS Status Indicators

Each power supply has two status indicator LEDs. The green PSU STATUS LED indicates the health of the local power supply. The red FRAME STATUS LED indicates the health of the entire frame and is operated by the frame status buss of the frame. The FRAME STATUS LED will be Off under normal conditions and On when there are Frame Status Fault conditions. See section 2.8 for more information about the frame status buss fault conditions.



On early versions of the 7700PS the FRAME STATUS LED is Green and will be On under normal conditions and Off when there are Frame Status Fault conditions.

If one of the power supplies malfunctions, (power cord disconnected, power switch is off, fuse is blown, rear fan is stopped, etc.) then its PSU STATUS LED will go Off, and the red FRAME STATUS LED on both power supplies will turn On. (If the power supplies are fitted with green FRAME STATUS LEDs they will turn Off) The PSU STATUS LED on the power supply that is functioning will remain On. If the frame is connected to VistaLINK® then the power supply fault will send a trap message from the frame.



If there is a fuse failure, contact Evertz customer service regarding the power supply immediately. The power supplies are short circuit protected and should not blow the fuse under a short circuit condition.

2.8. FRAME STATUS FAULT CONDITIONS

The Frame is fitted with a global Frame Status monitoring buss that is connected to each of the power supplies and to each of the modules. When a fault condition occurs on one of the power supplies, or one of the modules, a Frame Status Fault condition is active on the frame status buss. When this occurs the red FRAME STATUS LED on the power supply will come on and the relay on the Frame Status Tally terminal block will activate.

Power supplies, will assert a frame status fault when their PSU STATUS LED is off.

Each module has a large red LOCAL FAULT LED and a large green MODULE OK LED at the top of the card edge. This green LED indicates good module health while the red LED indicates that there is a fault condition on the module. Each module has its own criteria that determines when the red fault LED comes on. When the red LOCAL FAULT LED is On the module can also assert a fault condition on the Frame Status buss. On each module there is a jumper that disables sending local card fault information to the Frame Status Buss. For more information about fault conditions on individual modules, and for the location of the Frame Status Jumper on the module consult the individual chapter for the module. For example, if a module requires video or audio for its functionality and the video or audio is not present, the red LOCAL FAULT LED on the module will be On and the fault will be reported on the frame status buss if the FRAME STATUS jumper on the module is set to the On position (default).

2.8.1. Frame Status Tally Terminal Block

There is a green **FRAME STATUS** terminal block at the left rear of the frame that has a normally open and normally closed relay contact that can be used to indicate frame status fault conditions to external equipment. There are 4 connections.

Label	Pin #	Function
G	1	Chassis Ground (connect to cable shield)
R	2	Common (connect to Ground or your reference)
O	3	Open with respect to common when Frame Status fault exists
C	4	Closed with respect to common when Frame Status fault exists

Table 2-1: Frame Status Tally Terminal Block Pin Assignments

The relay contacts can sink up to 1A and operate up to 30 VDC.

2.9. CARE AND HANDLING OF OPTICAL FIBER

Some of the modules in the MVP™ system have fiber optic outputs. The following safety information applies to the optical outputs of these modules.

2.9.1. Safety

The **CLASS 1 LASER PRODUCT** sign will appear as the following image:



Background colour: Yellow
Triangular band: Black
Symbol: Black

2.9.2. Assembly

Assembly or repair of the laser sub-module is done solely at the Evertz facility, and is performed only by qualified Evertz technical personnel.

2.9.3. Labeling

Certification and Identification labels are combined into one label. As there is not enough room on the product to place the label, it is reproduced here in the manual. See Figure 2-4 below.

Note: There is not a date of manufacture on this label as it can be traced by the bar code label placed on the printed circuit board of each Evertz plug-in module

The Model number is one of: 3000MVP-PPMG, 3000MVP-PPMG13, 3000MVP-EO/OE-5



Figure 2-4: Reproduction of Laser Certification and Identification Label

2.9.4. Handling and Connecting Fibers



CAUTION: Never touch the end face of an optical fiber. Always keep dust caps on optical fiber connectors when not connected and always remember to properly clean the optical end face of a connector before making a connection.

Since the transmission characteristics of the fiber depend on the shape of the optical core, care must be taken to prevent fiber damage caused by heavy objects or abrupt fiber bending. Evertz recommends that you maintain a minimum bending radius of 5 cm to avoid fiber-bending loss that will decrease the maximum attainable distance of the fiber cable.

Dust particles on the ends of the optical fiber greatly increase the signal loss at interconnections, and large dust particles can even obscure light transmission altogether. To minimize the effects of dust contamination at the interconnections, the fiber should be cleaned each time it is mated or unmated. When using interconnection housings to mate two optical fibers, it is good practice to remove dust particles from the housing assembly with a blast of dry air. Alternatively, you can use the pre-moistened tissue that you should have received with the optical module. Remove this tissue from its package and wipe the end of the fiber connector before mating it to the module.

Whenever a fiber is unmated, it must be covered immediately. Most fiber manufacturers provide a plastic boot that fits over the ferrule body for this purpose.

Fiber interconnections must be made securely. The Evertz fiber optical transmitters and receivers come with SC interconnection housings built into the module. With this style of connector, the fiber assembly and the housing assembly can only be connected in one way and with very good repeatability. The rear fiber interconnect panel that is provided with each module can be ordered with optional SC/PC, ST/PC, or FC/PC connectors. The customer is required to provide the optical fiber with the correct connectors to connect the modules together. SC/PC, ST/PC, and FC/PC interconnection housing and connectors (as well as adapters) are industry standards with many available sources.

This page left intentionally blank

3. SPECIFICATIONS

3.1. 3000FR FRAME SPECIFICATIONS

3.1.1. Genlock

Type: NTSC (SMPTE 170M) and PAL (ITU624-4), colour black
Level: 1Vp-p
Connector: 2 BNC per IEC 61169-8 Annex A (1 each – NTSC and PAL)

3.1.2. Electrical

AC Mains Input: Auto ranging, 100 ⇔ 240 VAC, 50/60 Hz
Maximum Operating Current: 9.5 A (@ 115 VAC nominal), 4.0 A (@ 220 VAC nominal)
Maximum Power Consumption: 850 W
Maximum Module Load: 610 W (40 W per slot & 10 W for Frame Controller)
Power Supply Configuration: 1 supply standard, optional redundant supply requires separate inlet
Connector: IEC 60320 - 1 per power supply
Fuses: 5 x 20 mm. ceramic – 2 per power supply
 For 115 VAC operation: 10 amp, 250 Volt time delay
 For 230 VAC operation: 6.3 amp, 250 Volt time delay

Status Indicators (each power supply):

PSU status LED
Local Error/Failure LED

Tally Output Connector: 4 pin terminal, relay N/O, N/C for status/fault alarm, 1A, 30 VDC max.
Temperature: 0-40 deg. C. (optimal performance)
0-50 deg. C. (operating)

3.1.3. Compliance

Safety: CSA Listed to CSA C22.2 No. 60065-03, UL 60065-03
IEC 60065-(2001-12) 7th Edition
Complies with CE Low voltage Directive 93/68/EEC
EMC: Complies with FCC part 15, class A
Complies with EU EMC directive 89/336/EEC

3.1.4. Physical

Height: 10.5" (266 mm)
Width: 19" (483 mm)
Depth: 14.5" (368 mm)
Module Capacity: 15 single slot 300 series modules
Weight: Approx. 17.4 lbs. (7.9 Kg) with 2 power supplies, no slots occupied
Approx. 32 lbs. (14.5 Kg) with 2 power supplies all slots occupied

3.2. 3000FC FRAME CONTROLLER MODULE

The 3000FC Frame Controller module provides a single point of access to communicate with the 3000MVP series of cards. The 3000FC provides a 10Base-T/100Base-TX Ethernet port and handles all communications between the frame and the Maestro software, and serves as a gateway to individual cards in the frame. The 3000FC also provides an RS-232 serial port at the card edge to set up the network addresses.

The 3000FC is housed in a narrow slot underneath the left side power supply in the 3000FR Frame.

3.2.1. Specifications

3.2.1.1. Ethernet

Network Type: Fast Ethernet 100 Base-TX IEEE 802.3u standard for 100 Mbps baseband CSMA/CD local area network
Ethernet 10 Base-T IEEE 802.3 standard for 10 Mbps baseband CSMA/CD local area network

Connector: RJ-45 (on rear panel of 3000FR Frame)

3.2.1.2. Serial Communications

Standard: RS-232

Connector: 9-Pin Female D connector on upgrade breakout cable (provided with 3000FR)

Baud Rate: 57600

Format: 8 bits, no parity, 2 stop bits, no flow control

3.2.1.3. Electrical

Voltage: + 12VDC

Power: 7 Watts

EMI/RFI: Complies with FCC Part 15
Class A and EU EMC directive

3.3. 3000/3001MVP-OV-N

This broadcast video input module is equipped with eight BNC video inputs, labeled A-H. Each input can support composite analog (NTSC/PAL). There are two additional BNC outputs labeled PLINK OUT that are used, along with a coax cable, to connect this video input module to the output processor display modules.

3.3.1. Specifications

3.3.1.1. Video

Input Standards: NTSC (SMPTE 170M) and PAL (ITU-R BT.1700)
Number of Inputs: 8
Connector: BNC per IEC 61169-8 Annex A
Input Impedance: 75 Ohms
Signal Level (Analog): 1V nominal
DC Offset (Analog): 0V +/- 1V
Return Loss (Analog): >40Db up to 5MHz
Output: PLINK (x2) – Evertz Proprietary

3.3.1.2. Electrical

Voltage: +12V DC
Power: 40, all eight inputs
EMI/RFI: Complies with FCC Part 15, Class A, EU EMC Directive

3.3.1.3. Physical

Number of Slots: 1

3.3.2. Ordering Information

3000MVP-OV-N: 8 input Composite analog video input module
Ordering Options: None
Accessories: None

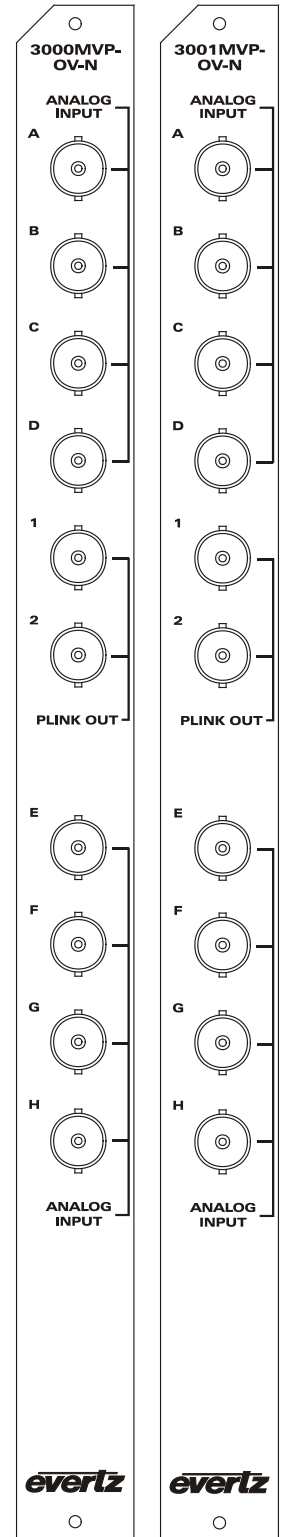

3.4. 3000/3001MVP-OV-SNX

This broadcast video input module is equipped with eight BNC video inputs, labeled A-H. Each input can auto-detect whether the input is SD-SDI or composite analog (NTSC/PAL). There are two additional BNC outputs labeled PLINK OUT that are used, along with a coax cable, to connect this video input module to the output processor display modules. The “SNX” was introduced to provide extended data services decode support, such as WST subtitle decode, WSS, Video Index decode, and thumbnailing.

3.4.1. Specifications

3.4.1.1. Video

Input Standards:	Auto-detecting SMPTE 259M-C, 525 or 625 lines component NTSC (SMPTE 170M) and PAL (ITU-R BT.1700)
Number of Inputs:	8
Connector:	BNC per IEC 61169-8 Annex A
Input Impedance:	75 Ohms
Equalization (Digital):	Automatic to >225m @ 270 Mb/s with Belden 8281 (equiv.)
Return Loss (SD-SDI):	> 15dB up to 270MHz
Jitter:	<0.2 UI
Embedded Audio:	SMPTE 272M-A
Signal Level (Analog):	1V nominal
DC Offset (Analog):	0V +/- 1V
Return Loss (Analog):	>40Db up to 5MHz
Output:	PLINK (x2) – Evertz Proprietary

3.4.1.2. Electrical

Voltage:	+12V DC
Power:	43W, all eight inputs
EMI/RFI:	Complies with FCC Part 15, Class A, EU EMC Directive

3.4.1.3. Physical

Number of slots:	1
-------------------------	---

3.4.2. Ordering Information

3000MVP-OV-SNX	8 input auto sensing SD/Composite analog video input module
Ordering Options:	None
Accessories:	None

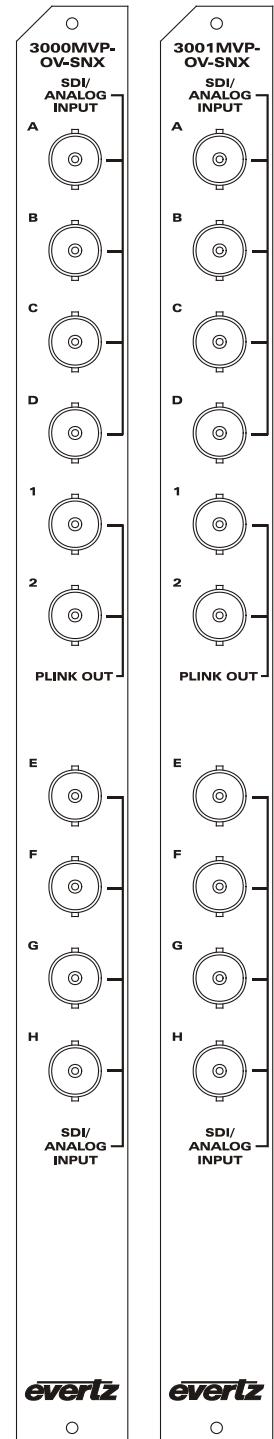

3.5. 3000MVP-OV-HSN

This broadcast video input module is equipped with eight (8) BNC video inputs, labeled A-H. Each input can auto-detect whether the input is HD-SDI, SD-SDI or composite analog (NTSC/PAL). In addition, there are two (2) additional BNC outputs labeled “PLINK OUT” which are used, along with a coax cable, to connect this video input module to the output processor display modules.

3.5.1. Specifications

3.5.1.1. Video

Standards:	Auto-detecting SMPTE 292M (1080i/60, 1080i/59.94, 1080i/50, 720p/60, 720p/59.94, 480p/60, 480p/59.94, 1080p/24sF, 1080p/23.98sF) SMPTE 259M-C, 525 or 625 lines component NTSC (SMPTE 170M) and PAL (ITU-R BT.1700)
Number of Inputs:	8
Connector:	BNC per IEC 61169-8 Annex A
Input Impedance:	75 Ohms
Equalization (SD-SDI):	Automatic to >225m @ 270 Mb/s with Belden 8281 (equiv.)
Equalization (HD-SDI):	Automatic to 100m @ 1.5Gb/s with Belden 1694 (equiv.)
Return Loss (Digital):	> 15dB up to 1.5 Gb/s
Jitter:	<0.2 UI
Embedded Audio:	SMPTE 272M-A (SD), SMPTE 299M (HD)
Signal Level (Analog):	1V nominal
DC Offset (Analog):	0V +/- 1V
Return Loss (Analog):	>40dB up to 5MHz
Output:	PLINK (x2) – Evertz Proprietary

3.5.1.2. Electrical

Voltage:	+12V DC
Power:	45W, all eight inputs
EMI/RFI:	Complies FCC Part 15, Class A, EU EMC Directive

3.5.1.3. Physical

Number of slots:	1
-------------------------	---

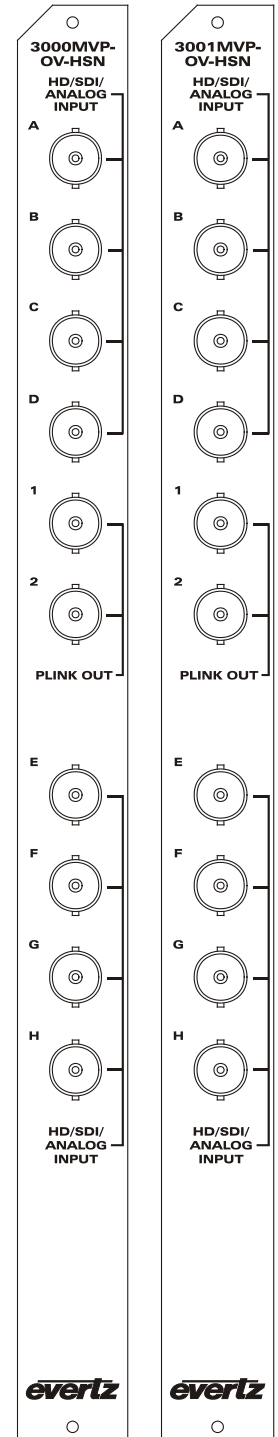

3.5.2. Ordering Information

3000MVP-OV-HSN 8 input auto sensing HD/SD/Composite analog video input module

Ordering Options: None

Accessories: None

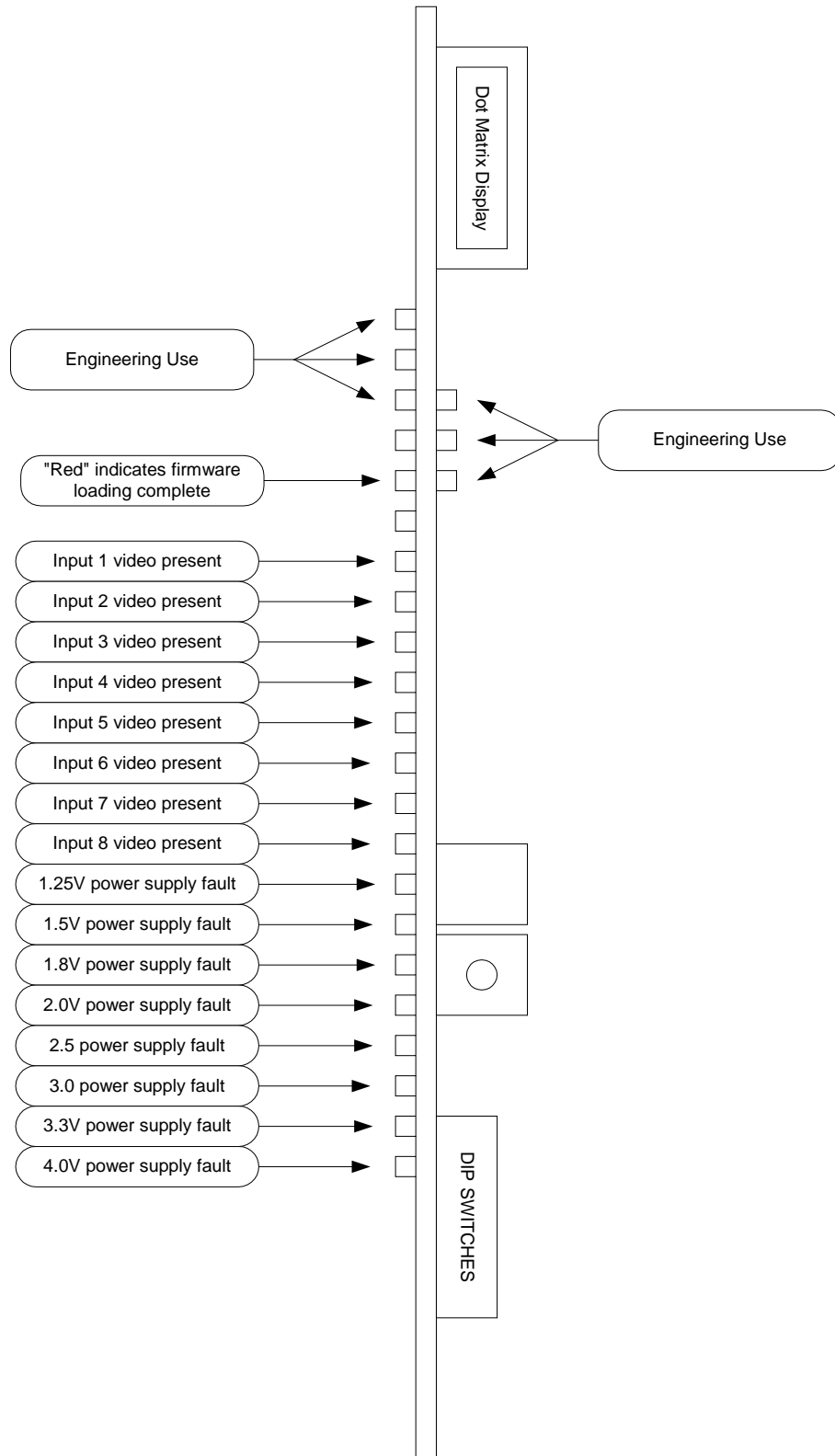

Figure 3-1: 3000MVP-OV-HSN and 3000MVP-GI Card LED Assignment

3.6. 3000MVP-OV-3G & 3001MVP-OV-HS

These broadcast video input modules are equipped with eight (8) BNC video inputs, labeled A-H. Each input can auto-detect whether the input is 3Gbps (3000MVP-OV-3G only), HD-SDI or SD-SDI. In addition, there are two (2) additional BNC outputs labeled “PLINK OUT” which are used, along with a coax cable, to connect this video input module to the output processor display modules.

3.6.1. Specifications

Please note: * denotes 3000MVP-OV-3G version only.

3.6.1.1. Video

Standards:	Auto-detecting SMPTE 424M (1080p/59.94, 1080p/50) SMPTE 292M (1080i/60,1080i/59.94, 1080i/50, 720p/60, 720p/59.94, 480p/60, 480p/59.94, 1080p/24sF, 1080p/23.98sF) SMPTE 259M-C, 525 or 625 lines component
Number of Inputs:	8
Connector:	BNC per IEC 61169-8 Annex A
Input Impedance:	75 Ohms
Equalization (SD-SDI):	Automatic to >225m @ 270 Mb/s with Belden 8281 (equiv.)
Equalization (HD-SDI):	Automatic to 100m @ 1.5Gb/s with Belden 1694A (equiv.)
* Equalization (3Gbps):	* Automatic to 50m @ 3Gb/s with Belden 1694A (equiv.)
Return Loss (Digital):	> 15dB up to 1.5 Gb/s
Jitter:	<0.2 UI
Embedded Audio:	SMPTE 272M-A (SD), SMPTE 299M (HD)
Output:	PLINK (x2) – Evertz Proprietary

3.6.1.2. Electrical

Voltage:	+12V DC
Power:	50W, all eight inputs
EMI/RFI:	Complies FCC Part 15, Class A, EU EMC Directive

3.6.1.3. Physical

Number of slots:	1
-------------------------	---

3.6.2. Ordering Information

3000MVP-OV-3G	8 input auto sensing 3G/HD/SD video input module
3000MVP-OV-HS	8 input auto sensing HD/SD video input module
Ordering Options:	None
Accessories:	None

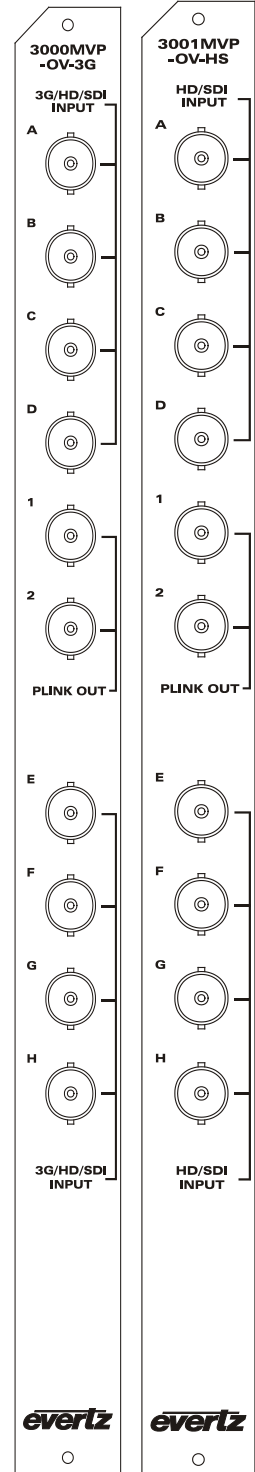

3.7. 3000MVP-GI-2, 3001MVP-GI-2-ED AND 3000MVP-GI-4, 3001MVP-GI-4-ED

These computer video (progressive RGBHV or DVI) input modules are equipped with either two (2) or four (4) inputs, respectively. The 3000MVP-GI-2/3001MVP-GI-2-ED can accept up to two computer inputs from VGA (640 x 480) to UXGA (1600 x 1200) resolution. Similarly the 3000MVP-GI-4/3001MVP-GI-4-ED module can accept up to 4 computer inputs. There are also two (2) additional BNC outputs labeled “PLINK OUT” which are used, along with a coax cable, to connect this input module to the output processor display module.

Each model is shipped with DVI to VGA adaptors. Additional adaptors can be ordered from Evertz- see the ordering information in section 3.7.2.

Computer Input Resolutions Supported		
640x480/60	640x480/72	640x480/75
640x480/85	800x600/60	800x600/72
800x600/75	800x600/85	1024x768/60
1024x768/70	1024x768/75	1024x768/85
1280x1024/60	1280x1024/75	1600x1200/60

3.7.1. Specifications

3.7.1.1. Graphics Inputs

Standards:	Auto-detecting, VESA (DVI-I, for DVI and RGBHV inputs)
Number of Inputs:	2 on 3000MVP-GI-2, 3001MVP-GI-2-ED 4 on 3000MVP-GI-4, 3001MVP-GI-4-ED
Connector:	DVI-I
Input Resolution:	640 x 480 to 1600 x 1200 – See table
Signal Level:	1V nominal

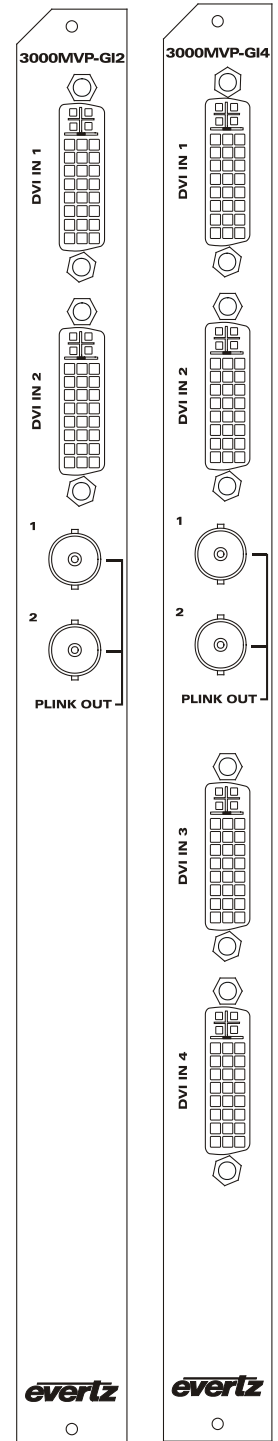

3.7.1.2. Outputs

Standard: PLINK – Evertz Proprietary
Number of Outputs: 2
Connector: BNC per IEC 61169-8 Annex A

3.7.1.3. Electrical

Voltage: +12V DC
Power: 40 to 45 W
EMI/RFI: Complies with FCC Part 15, Class A, EU EMC Directive

3.7.1.4. Physical

Number of slots: 1

3.7.2. Ordering Information

3000/3001MVP-GI-2 Dual computer video auto sensing input module
3000/3001MVP-GI-4 Quad computer video auto sensing input module

Ordering Options: None

Accessories: JDVIVGAMF DVI to VGA Adapter (One included for each graphics input)

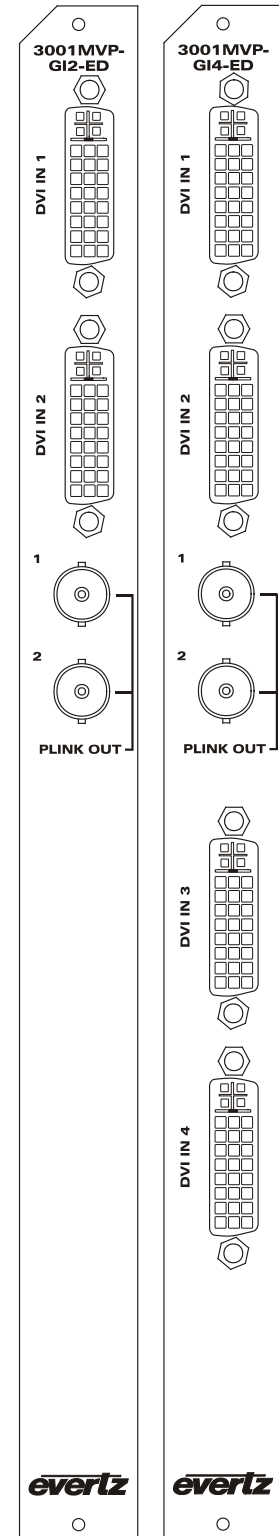

3.8. 3000MVP-AI AND 3000MVP-AI-AESU

The 3000MVP-AI handles up to 64 channels of analog audio (or up to 2 groups of analog audio per video input) and 32 AES inputs. The 3000MVP-AI-AES supports 32 unbalanced AES inputs only. Audio is applied to the MVP via dual SCSI connectors on the rear plate with optional BNC and terminal block connectors via breakout panels. Balanced and unbalanced audio inputs are supported via these breakout panels as depicted below.

3.8.1. Specifications

3.8.1.1. Audio Inputs

Standards:	SMPTE 276M, single ended AES (unbalanced) Balanced analog audio
Number of Inputs:	64 channel Analog Audio 32 channel AES/EBU
Connector:	Dual 68-pin SCSI (x3 sets) – balanced or unbalanced breakout panels available
Resolution (Digital):	24-bit
Impedance (Digital):	75 Ohm unbalanced
Impedance (Analog):	20 kOhms minimum (differential)
Sampling Frequency:	48 kHz (both Digital and Analog inputs)
Peak Signal & Common Mode:	30 dBu (Analog)

3.8.1.2. Electrical:

Voltage:	+12V DC
Power:	35W
EMI/RFI:	Complies FCC Part 15, Class A, EU EMC Directive

3.8.1.3. Physical

Number of slots:	1
-------------------------	---

3.8.2. Ordering Information

3000MVP-AI	Discrete input audio module
3000MVP-AI+BHPBAL	Discrete input audio module with balanced break out panel (Analog audio and/or balanced AES/EBU inputs)
3000MVP-AI+BHPU	Discrete audio input module with BNC break out panel (unbalanced AES/EBU inputs)
3000MVP-AI+BHPU+BHPBAL	Audio module with both BHP breakout panels

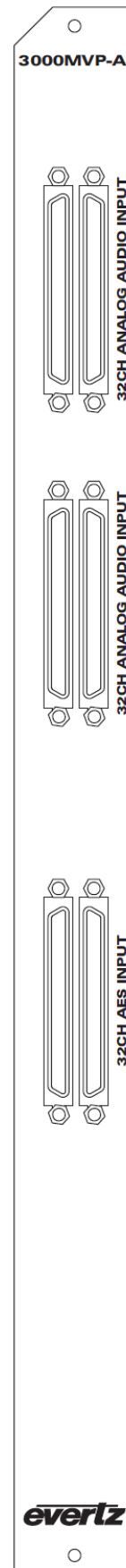

Ordering Options: None

Accessories: BHP and SCSI cable as per table below

3.8.2.1. 3000MVP-AI BHP Combinations and Ordering Information:

Audio Input Type	BHP Type	Ordering Information
Single ended (75 ohm) AES/EBU audio	3000BHP-U	3000MVP-AI+BHPU
Balanced (110 ohm) AES/EBU audio	3000BHP-BAL	3000MVP-AI+BHPBAL
Balanced analog stereo pair	3000BHP-BAL	3000MVP-AI+BHPBAL

3.8.2.2. 3000MVP-AI SCSI Pin-out Detail (AES or Analog Audio)

SCSI Pin #	Balanced AES Input	Unbalanced AES Input	Analog Audio Input (SCSI 1/SCSI 2)	SCSI Pin #	Balanced AES Input	Unbalanced AES Input	Analog Audio Input (SCSI 1/SCSI 2)
1	AES 16+	AES 16	16+ / 48+	35	AES 16-	GND	16- / 48-
2	AES 8-	GND	8- / 40-	36	AES 8+	AES 8	8+ / 40+
3	AES 15+	AES 15	15+ / 47+	37	AES 15-	GND	15- / 47-
4	AES 7-	GND	7- / 39-	38	AES 7+	AES 7	7+ / 39+
5	AES 14+	AES 14	14+ / 46+	39	AES 14-	GND	14- / 46-
6	AES 6-	GND	6- / 38-	40	AES 6+	AES 6	6+ / 38+
7	AES 13+	AES 13	13+ / 45+	41	AES 13-	GND	13- / 45-
8	AES 5-	GND	5- / 37-	42	AES 5+	AES 5	5+ / 37+
9	AES 12+	AES 12	12+ / 44+	43	AES 12-	GND	12- / 44-
10	AES 4-	GND	4- / 36-	44	AES 4+	AES 4	4+ / 36+
11	AES 11+	AES 11	11+ / 43+	45	AES 11-	GND	11- / 43-
12	AES 3-	GND	3- / 35-	46	AES 3+	AES 3	3+ / 35+
13	AES 10+	AES 10	10+ / 42+	47	AES 10-	GND	10- / 42-
14	AES 2-	GND	2- / 34-	48	AES 2+	AES 2	2+ / 34+
15	AES 9+	AES 9	9+ / 41+	49	AES 9-	GND	9- / 41-
16	AES 1-	GND	1- / 33-	50	AES 1+	AES 1	1+ / 33+
17	N/C	N/C	N/C	51	N/C	N/C	N/C
18	N/C	N/C	N/C	52	N/C	N/C	N/C
19	AES 32-	GND	32- / 64-	53	AES 32+	AES 32	32+ / 64+
20	AES 24+	AES 24	24+ / 56+	54	AES 24-	GND	24- / 56-
21	AES 31-	GND	31- / 63-	55	AES 31+	AES 31	31+ / 63+
22	AES 23+	AES 23	23+ / 55+	56	AES 23-	GND	23- / 55-
23	AES 30-	GND	30- / 62-	57	AES 30+	AES 30	30+ / 62+
24	AES 22+	AES 22	22+ / 54+	58	AES 22-	GND	22- / 54-
25	AES 29-	GND	29- / 61-	59	AES 29+	AES 29	29+ / 61+
26	AES 21+	AES 21	21+ / 53+	60	AES 21-	GND	21- / 53-
27	AES 28-	GND	28- / 60-	61	AES 28+	AES 28	28+ / 60+
28	AES 20+	AES 20	20+ / 52+	62	AES 20-	GND	20- / 52-
29	AES 27-	GND	27- / 59-	63	AES 27+	AES 27	27+ / 59+
30	AES 19+	AES 19	19+ / 51+	64	AES 19-	GND	19- / 51-
31	AES 26-	GND	26- / 58-	65	AES 26+	AES 26	26+ / 58+
32	AES 18+	AES 18	18+ / 50+	66	AES 18-	GND	18- / 50-
33	AES 25-	GND	25- / 57-	67	AES 25+	AES 25	25+ / 57+
34	AES 17+	AES 17	17+ / 49+	68	AES 17-	GND	17- / 49-

Note: Two mounting pins connected to ground (GND).

3.9. 3000MVP-PPV-9 AND 3000MVP-PPV-9+D

The “PPV” module processes the input signals from each of the input modules and provides an output display based on the user’s configuration via MVP Maestro GUI software. Connections between the input modules and the output process/display module are made using a single coax cable with standard BNC connectors on both ends, connecting one “PLINK OUT” on the input module with one “PLINK IN” on the output processor module. The “PPV-9” is equipped with nine (9) “PLINK IN” input BNC connectors. The module is equipped with a DVI-I output, providing both DVI and RGBHV outputs with the same display content. Furthermore, dual SCSI connectors provide auxiliary I/O connections such as GPI/GPO, audio monitoring outputs, serial ports (232/422) and LTC inputs.

The dual output “+D” is a factory-set option and provides two independent DVI outputs from the same module. Outputs are provided on the same DVI connector and are broken out using the WP3000BHPDVIO cable. If you are not sure whether your unit is a PPV or a PPV+D, the card edge LED display will provide specific information.

3.9.1. Specifications

3.9.1.1. Video Inputs

Input Standard:	PLINK (Evertz Proprietary)
Number of Inputs:	9x PLINK (supports up to 9 video input modules)
3000MVP-PPV-9/-9+D:	
Input Connector:	BNC per IEC 61169-8 Annex A
Termination:	75 Ohms
Equalization:	Automatic 20m Belden 1694 (equiv.)
Return Loss:	> 15dB

3.9.1.2. Video Output

Type:	DVI-I (on PPVs); dual DVI (on PPV+D)
Connector:	DVI-I

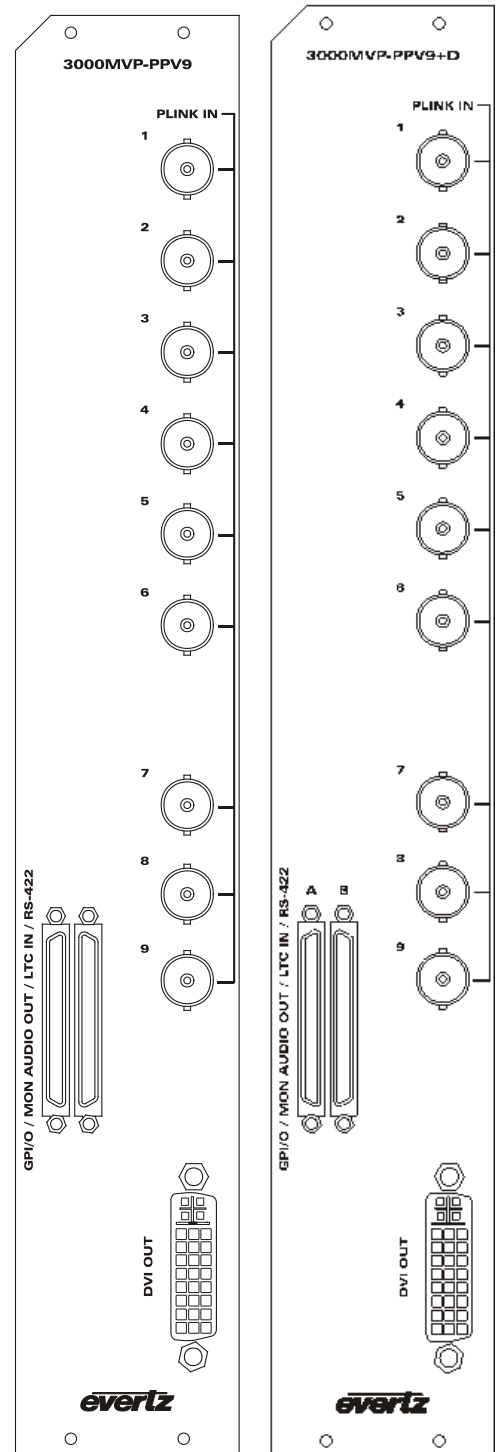

3.9.1.3. Auxiliary Outputs

Connector:	68-pin dual SCSI (to one or two 3000BHP-AUX)
Audio Monitoring Outputs:	4 AES unbalanced
General Purpose Inputs:	64
General Purpose Outputs:	44
LTC Input:	Differential 0.5 to 2 V P-P
Data I/O Serial Port:	1 serial port (RS232 or RS422)

3.9.1.4. Electrical

Voltage:	+12V DC
Power:	50-60W
EMI/RFI:	Complies w/ FCC Part 15, Class A, EU EMC Directive

3.9.1.5. Physical

Number of slots:	2
-------------------------	---

3.9.2. Ordering Information

3000MVP-PPV-9	Single output display processor module – 9 PLINK video inputs
3000MVP-PPV-9+D	Dual output display processor module – 9 PLINK video inputs
Ordering Options:	3000BHP-AUX (one included with every PPV module) WP3000BHPDVIO (one included with every “+D” module)

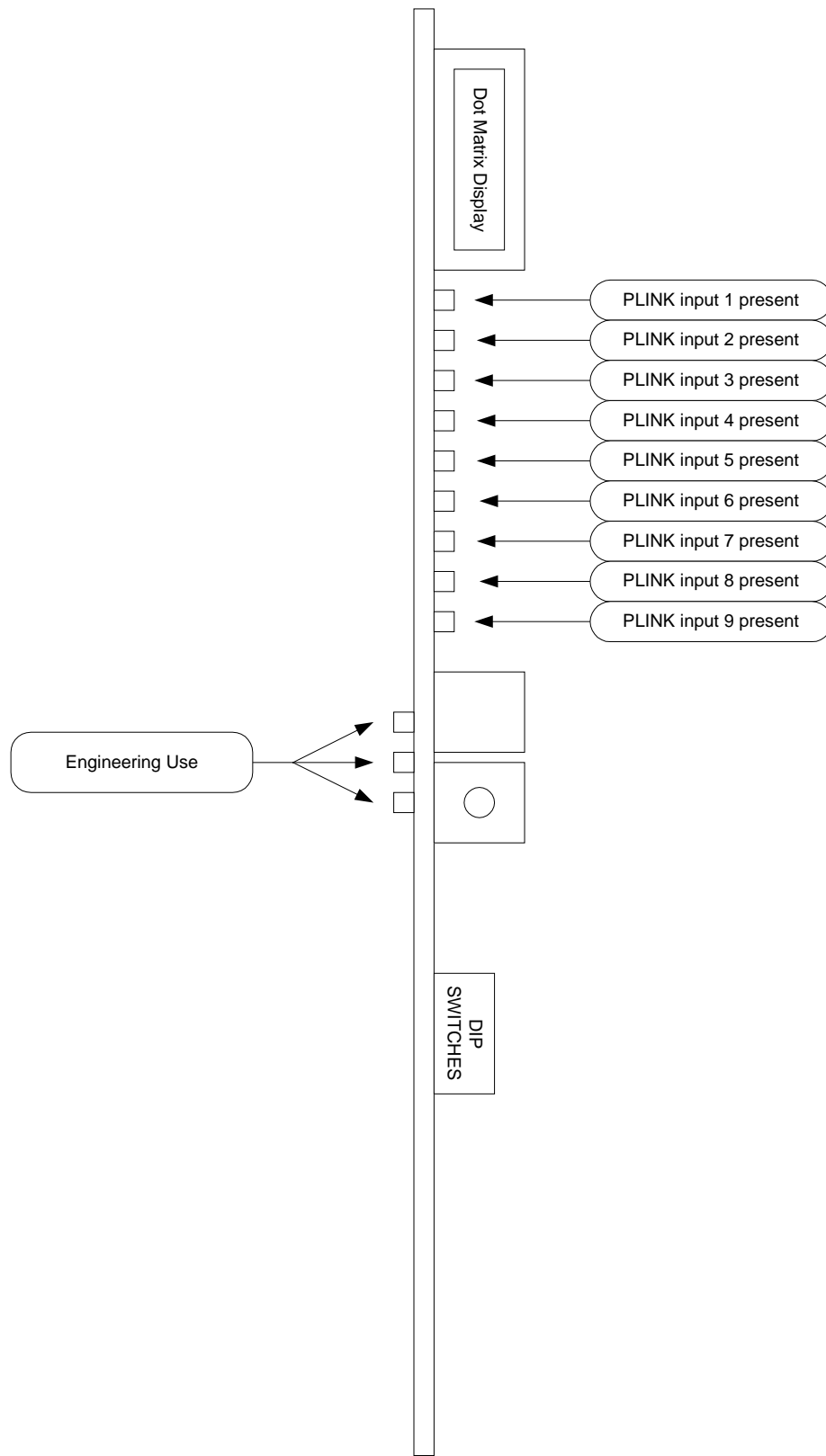

Figure 3-2: 3000MVP-PPV-9 card LED assignment

3.10. 3000MVP-PPMV13

The “PPMV” module processes the input signals of up to 13 input modules and drives four independent output displays based on the user’s configuration via MVP Maestro GUI software. The 3-slot modules fit into a 3000FR frame and the connection between an input module and the PPMV are made using a single coax cable with standard BNC connectors on both ends. The user is required to connect one “PLINK OUT” on the input module to one “PLINK IN” on the output processor module. There are thirteen (13) “PLINK IN” input BNC connectors on each module.

The “PPMV” module comes with two dual DVI outputs to drive 4 SXGA displays or 2 UXGA or greater displays via DVI-D breakout or 4 HD-SDI serial outputs via BNC connectors. This module comes equipped with two dual DVI break out cables providing the user with four DVI extensions to the displays. The PPMV also offers 4 HD-SDI outputs, which provide the same content as the DVI outputs best fit to a HD-SDI raster. For example, if the DVI resolution is set to 1280x720p then the HD-SDI output will be 720p, however for all other DVI resolutions the HD-SDI output will be 1920x1080i. The “PPMV+G” modules add an additional 4 fiber GLINK outputs.

In the “PPMV” modules, dual SCSI connectors provide auxiliary I/O connections such as GPI/GPO, audio monitoring outputs, serial ports (232/422) and LTC inputs.

3.10.1. Specifications

3.10.1.1. Video Input

Input Standard:	PLINK (Evertz Proprietary)
Number of Inputs:	13 (3000MVP-PPMV13)
Connector:	BNC per IEC 61169-8 Annex A
Impedance:	75 Ohms
Equalization:	Automatic 20m Belden 1694 (equiv.)
Return Loss:	> 15dB

3.10.1.2. HD SDI Outputs

Type:	HD-SDI
Connector:	BNC per IEC 61169-8 Annex A
Number:	4

3.10.1.3. DVI Outputs

Type:	dual DVI
Connector:	DVI-I
Output Resolution:	640 x 480 to 1600 x 1200
Signal Level:	1V nominal
Number:	2

3.10.1.4. Optical Outputs

Type:	G-LINK Optical (Evertz Proprietary) - on PPMV+G only
Connector:	Female SC/PC, ST/PC or FC/PC (SC/PC is standard)
Number:	4
Return Loss:	> 14 dB
Rise and Fall Time:	200 ps nominal
Wide Band Jitter:	< 0.20UI
Fiber Size:	9 μm core / 125 μm overall
Wavelength:	1310nm (nominal)
Output Power:	-7dBm ± 1dBm

3.10.1.5. Auxiliary Outputs

Connector:	68-pin dual SCSI – to 3000BHP-AUX breakout panel
Audio Monitoring Outputs:	4 AES unbalanced
Connector:	BNC per IEC 61169-8 Annex A on breakout panel
General Purpose Inputs:	64
General Purpose Outputs:	44
LTC Input:	Differential 0.5 to 2 V P-P
Data I/O Serial Port:	1 serial port (RS232 or RS422)

3.10.1.6. Electrical Specification

Voltage:	+12V DC
Power:	75W to 105W
EMI/RFI:	Complies w/ FCC Part 15, Class A, EU EMC Directive

3.10.1.7. Physical

Number of slots:	3
-------------------------	---

3.10.2. Ordering Information

3000MVP-PPMV13	Multi output display processor module – 13 PLINK inputs, HDSDI and DVI out
Ordering Options:	3000BHP-AUX (one included with every module) WP3000BHPDVIO (one included with every PPMG module and two with every PPMV module)

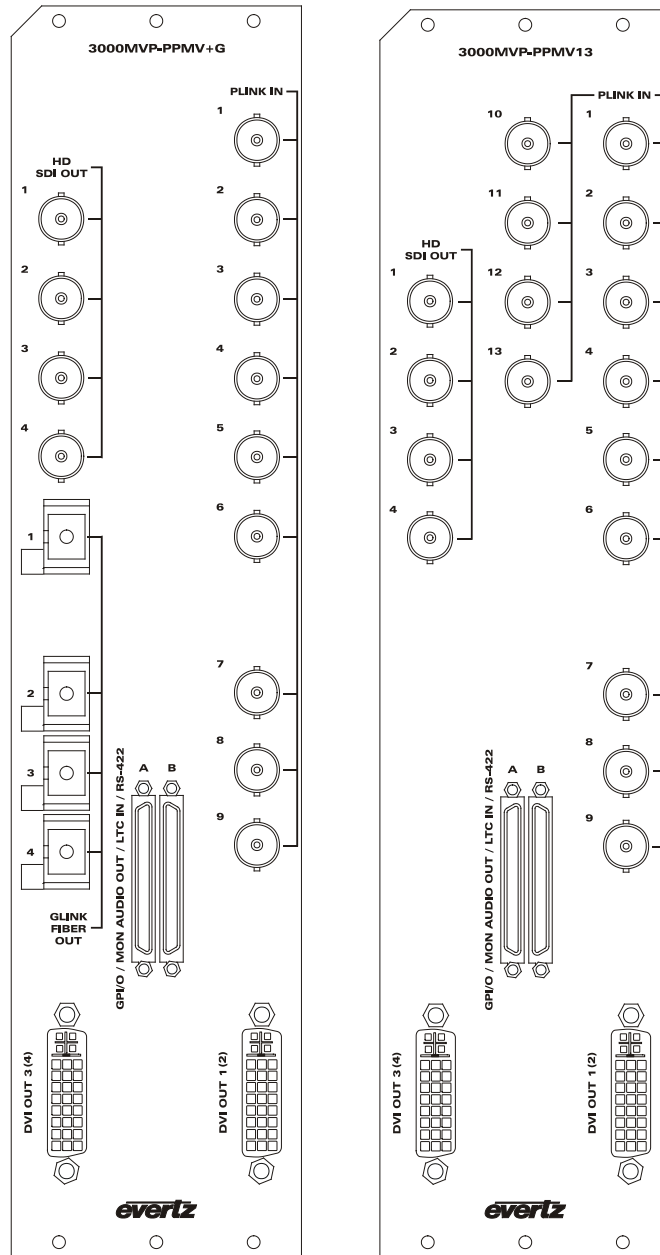

3.11. 3000MVP-PPMX16-4G, 3000MVP-PPMX16-4H4G & 3000MVP-PPMX16-4H4V

The “PPMX” modules process the input signals from up to 16 input modules and drive four independent output displays based on the user’s configuration via the MVP Maestro GUI software. The 3-slot modules fit into a 3000FR frame and the connection between an input module and the PPMX are made using a single coax cable with standard BNC connectors on both ends. The user is required to connect one “PLINK OUT” on the input module to one “PLINK IN” on the output processor module. On each PPMX16 module there are sixteen (16) “PLINK IN” input BNC connectors.

The “PPMX16-4G” is equipped with 4 G-Link outputs (Evertz proprietary serial connection) to drive resolution up to WUXGA (1920x1200) including HDTV (1920x1080) and UXGA on all 4 outputs. The G-Link output provides a 10m cable length over coax and also provides a built-in extension over fiber (75m via multi-mode fiber and up to 10km – subject to sufficient loss budget - using single mode fiber). A 2430GDAC is required to convert the G-Link signal back to VGA or DVI at the display end of the link.

The “PPMX16-4H4G” is equipped with 4 fiber G-Link outputs (Evertz proprietary serial connection) to drive resolution up to WUXGA (1920x1200) including HDTV (1920x1080) and UXGA on all 4 outputs. The G-Link provides a built-in DVI extension over fiber (75m via multi-mode fiber and up to 10km – subject to sufficient loss budget - using single mode fiber). A 2430GDAC is required to convert the G-Link signal back to VGA or DVI at the display end of the link. The “4H4G” also offers 4 HD-SDI outputs, which provide the same content as the DVI outputs best fit to a HD-SDI raster. For example, if the DVI resolution is set to 1280x720p then the HD-SDI output will be 720p, however for all other DVI resolutions the HD-SDI output will be 1920x1080i. The best fit resolutions for using the HD-SDI output which is parallel to the GLINK output is either 1280x720 = 720p over HD-SDI, or 1920x1080p = 1920x1080i over HD-SDI.

The “PPMX16-4H4V” is equipped with 4 DVI outputs which can be driven up to WUXGA (1920x1200). The “4H4V” also offers 4 HD-SDI outputs which provide the same content as the DVI outputs best fit to a HD-SDI raster. For example, if the DVI resolution is set to 1280x720p then the HD-SDI output will be 720p, however, for all other DVI resolutions the HD-SDI output will be 1920x1080i. The best fit resolutions for using the HD-SDI output which is parallel to the GLINK output is either 1280x720 = 720p over HD-SDI, or 1920x1080p = 1920x1080i over HD-SDI.

Dual SCSI connectors on the back plate provide auxiliary I/O connections such as GPI/GPO, audio monitoring outputs, serial ports (232/422) and LTC inputs.

3.11.1. Specifications

3.11.1.1. Video Input

Input Standard:	PLINK (Evertz Proprietary)
Number of Inputs:	16
Connector:	BNC per IEC 61169-8 Annex A
Impedance:	75 Ohms
Equalization:	Automatic 20m Belden 1694 (equiv.)
Return Loss:	> 15dB

3.11.1.2. GLINK Outputs

Type: G-LINK (Evertz Proprietary)
Connector: BNC per IEC 61169-8 Annex A
Number: 4 (3000MVP-PPMX16-4G only)

3.11.1.3. Optical Outputs

Type: G-LINK Optical (Evertz Proprietary)
Connector: Female SC/PC, ST/PC or FC/PC (SC/PC is standard)
Number: 4
Return Loss: > 14 dB
Rise and Fall Time: 200 ps nominal
Wide Band Jitter: < 0.20UI
Fiber Size: 9 μ m core / 125 μ m overall
Wavelength: 1310nm (nominal)
Output Power: -7dBm \pm 1dBm

3.11.1.4. HD SDI Outputs

Type: HD-SDI
Connector: BNC per IEC 61169-8 Annex A
Number: 4 (3000MVP-PPMX16-4H4G)

3.11.1.5. Auxiliary Outputs

Connector: 68-pin dual SCSI – to 3000BHP-AUX breakout panel
Audio Monitoring Outputs: 4 AES unbalanced
Connector: BNC per IEC 61169-8 Annex A on breakout panel
General Purpose Inputs: 64
General Purpose Outputs: 32
LTC Input: Differential 0.5 to 2 V P-P
Data I/O Serial Port: 1 serial port (RS232 or RS422)

3.11.1.6. DVI Outputs

Type: DVI
Connector: DVI-I
Output Resolution: 640 x 480 to 1920 x 1200
Signal Level: 1V nominal
Number: 4

3.11.1.7. Electrical Specification

Voltage: +12V DC
Power: 105 to 110 W
EMI/RFI: Complies w/ FCC Part 15, Class A, EU
EMC Directive

3.11.1.8. Physical

Number of Slots: 3

3.11.2. Ordering Information

3000MVP-PPMX16-4G Multi output display processor module – 16 PLINK inputs, GLINK outputs
3000MVP-PPMX16-4H4G Multi output display processor module – 16 PLINK inputs, 4 HD-SDI outputs and 4 GLINK outputs
3000MVP-PPMX16-4H4V Multi output display processor module – 16 PLINK inputs, 4 HD-SDI outputs and 4 DVI-I outputs

Ordering Options: 3000BHP-AUX (one included with every module)

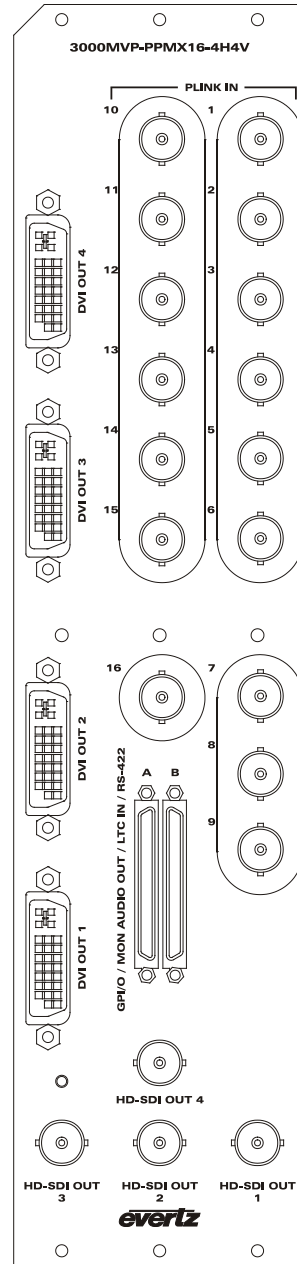
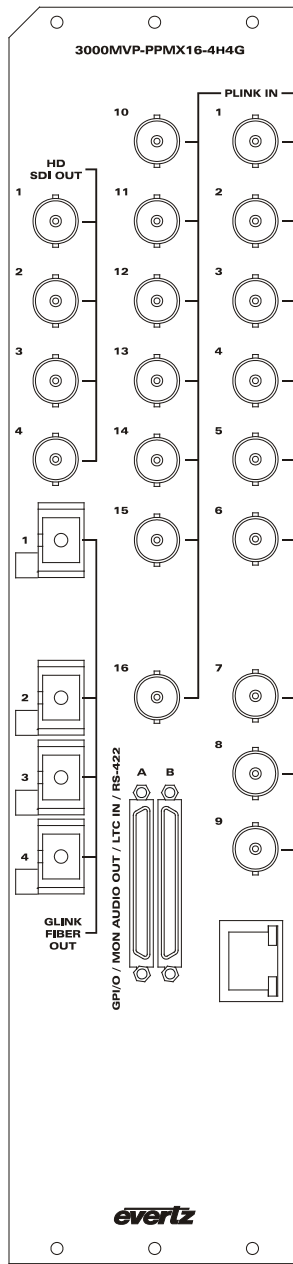
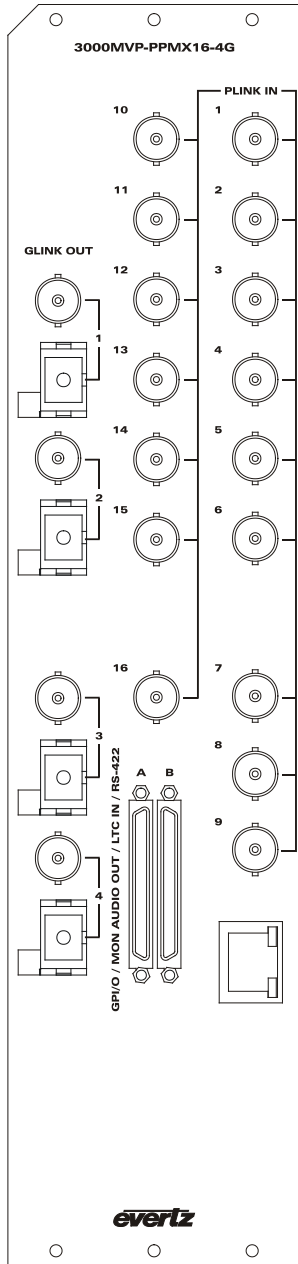

3.12. 3000MVP-PPMX16-8G AND 3000MVP-PPMX16-8GC

The “PPMX” modules process the input signals from up to 16 input modules and drive eight independent output displays based on the user’s configuration via the MVP Maestro GUI software. The 3-slot modules fit into a 3000FR frame and the connection between an input module and the PPMX are made using a single coax cable with standard BNC connectors on both ends. The user is required to connect one “PLINK OUT” on the input module to one “PLINK IN” on the output processor module. On each PPMX16 module there are sixteen (16) “PLINK IN” input BNC connectors.

The “PPMX16-8G” is equipped with 8 G-Link outputs (Evertz proprietary serial connection) to drive resolution up to HDTV (1920x1080) and UXGA on all 8 outputs. The G-Link output provides a built-in DVI extension over fiber (75m via multi-mode fiber and up to 10km – subject to sufficient loss budget - using single mode fiber). A 2430GDAC is required to convert the G-Link signal back to VGA or DVI at the display end of the link.

The “PPMX16-8GC” is equipped with 8 coax G-Link outputs (Evertz proprietary serial connection) to drive resolution up to HDTV (1920x1080) and UXGA on all 8 outputs. The G-Link provides a built-in DVI extension over coax (10m via Belden 1694A). A 2430GDAC is required to convert the G-Link signal back to VGA or DVI at the display end of the link.

Dual SCSI connectors on the back plate provide auxiliary I/O connections such as GPI/GPO, audio monitoring outputs, serial ports (232/422) and LTC inputs.

3.12.1. Specifications

3.12.1.1. Video Input

Input Standard:	PLINK (Evertz Proprietary)
Number of Inputs:	16
Connector:	BNC per IEC 61169-8 Annex A
Impedance:	75 Ohms
Equalization:	Automatic 20m Belden 1694 (equiv.)
Return Loss:	> 15dB

3.12.1.2. GLINK Outputs

Type:	G-LINK (Evertz Proprietary)
Connector:	BNC per IEC 61169-8 Annex A
Number:	8 (3000MVP-PPMX16-8GC only)

3.12.1.3. Optical Outputs

Type:	G-LINK Optical (Evertz Proprietary)
Connector:	Female SC/PC, ST/PC or FC/PC (SC/PC is standard)
Number:	8 (3000MVP-PPMX16-8G only)
Return Loss:	> 14 dB
Rise and Fall Time:	200 ps nominal

Wide Band Jitter: < 0.20UI
Fiber Size: 9 μm core / 125 μm overall
Wavelength: 1310nm (nominal)
Output Power: -7dBm ± 1dBm

3.12.1.4. Auxiliary Outputs

Connector: 68-pin dual SCSI – to 3000BHP-AUX breakout panel
Audio Monitoring Outputs: 4 AES unbalanced

Connector: BNC per IEC 61169-8 Annex A on breakout panel
General Purpose Inputs: 64
General Purpose Outputs: 32
LTC Input: Differential 0.5 to 2 V P-P
Data I/O Serial Port: 1 serial port (RS232 or RS422)

3.12.1.5. Electrical Specification

Voltage: +12V DC
Power: 105 to 110 W
EMI/RFI: Complies w/ FCC Part 15, Class A, EU
EMC Directive

3.12.1.6. Physical

Number of slots: 3

Ordering Information:
3000MVP-PPMX16-8G Multi output display processor module – 16 PLINK inputs, 8 fiber GLINK outputs
3000MVP-PPMX16-8GC Multi output display processor module – 16 PLINK inputs, 8 coax GLINK outputs

Ordering Options: 3000BHP-AUX (one included with every module)

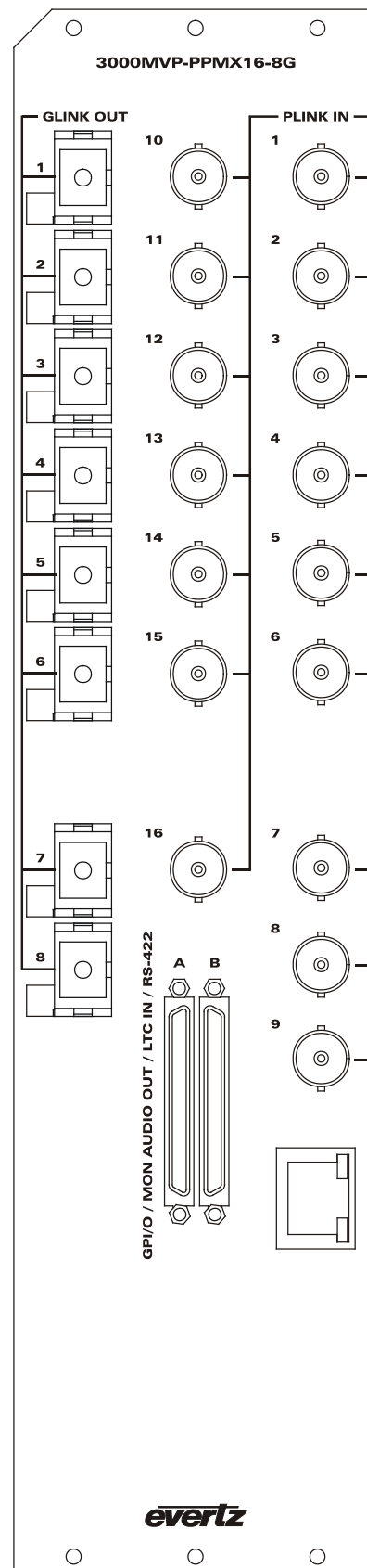
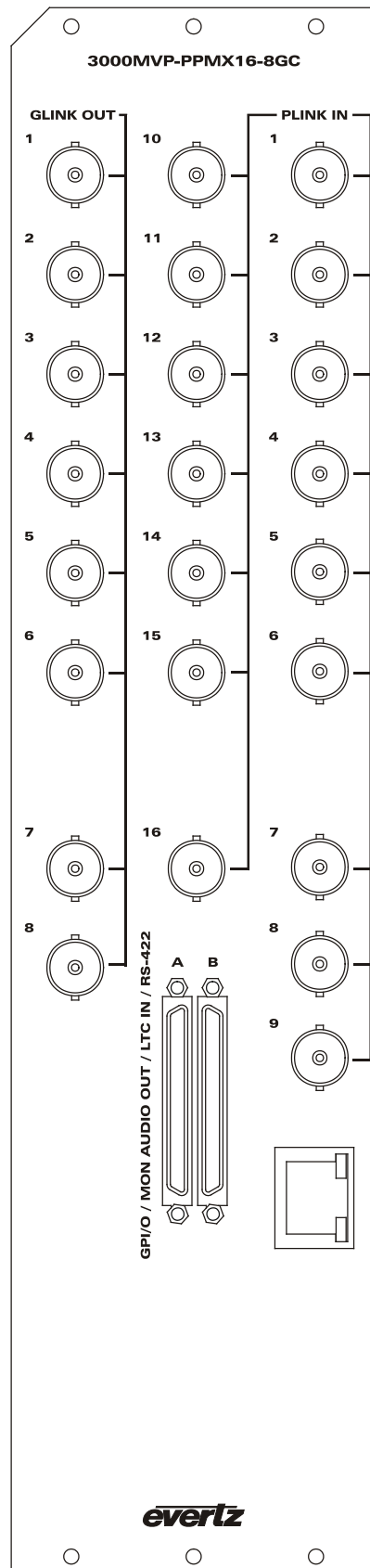

3.13. 3000MVP-PPR-16X16

The 3000MVP-PPR-16x16 module is a PLINK packet router. Using PLINK (patent-pending technology) the router allows up to 16 input cards to be connected to up to 16 displays, and provide any input to any output.

Due to its ability to place any input on any output display, using the PPR router can virtually eliminate the need for an upstream router feeding the MVP.

Interconnect from the input cards to the PPR or the PPR to the display cards is achieved using Belden 1694A coax cable over lengths up to 10 m (30 feet).

3.13.1. Specifications

3.13.1.1. Video Input

Standard:	PLINK (Evertz Proprietary)
Number of Inputs:	16 (3000MVP-PPR-16x16)
Input Connector:	BNC per IEC 61169-8 Annex A
Termination:	75 Ohms
Equalization:	Automatic 10m Belden 1694 (equiv.)
Return Loss:	> 15dB

3.13.1.2. Video Output

Standard:	PLINK (Evertz Proprietary)
Number of Outputs:	16 (3000MVP-PPR-16x16)

3.13.1.3. Electrical

Voltage:	+12V DC
Power:	80W
EMI/RFI:	Complies with FCC Part 15, Class A, EU EMC Directive

3.13.1.4. Physical

Number of slots:	3
-------------------------	---

3.13.2. Ordering Information

3000MVP-PPR-16x16: 16 Input x 16 output PLINK Packet Router module

Ordering Options: None

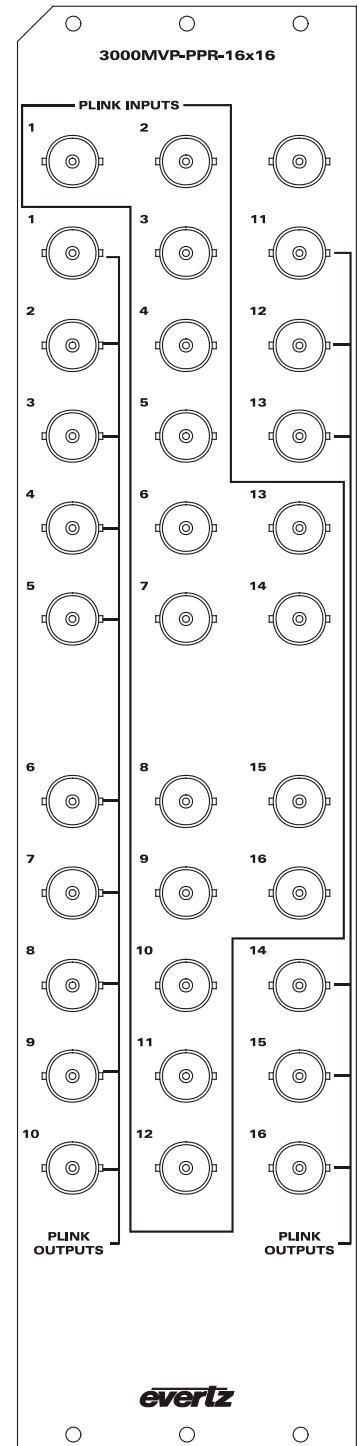

3.14. 3000MVP-GLINK4

These GLINK input modules accept GLINK sources directly from GLINK enabled display devices, such as the 3000MVP-PPMG and the 7707RGT-GC. The device is capable of supporting any of the output video standards supported by the above mentioned devices.

3.14.1. Specifications

3.14.1.1. Video Inputs

Type: GLINK (Evertz proprietary)
Number of Inputs: 4
Connector: BNC per IEC 61169-8 Annex A
Impedance: 75 Ohms

3.14.1.2. Video Outputs

Type: PLINK – Evertz Proprietary
Number of Outputs: 2
Connector: BNC per IEC 61169-8 Annex A

3.14.1.3. Electrical

Voltage: +12V DC
Power: 45 W
EMI/RFI: Complies with FCC Part 15, Class A, EU EMC Directive

3.14.1.4. Physical

Number of slots: 1

3.14.2. Ordering Information

3000MVP-GLINK4 Quad GLINK input card
Ordering Options: None

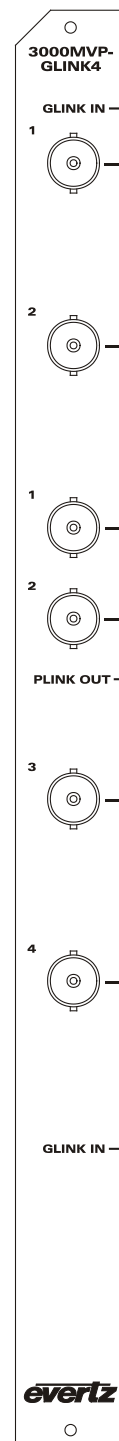

3.15. 3000MVP-OE-5 AND 3000MVP-EO-5

The 3000MVP-OE-5 and EO-5 are optical to electrical and electrical to optical conversion modules. The primary function of this module is to extend the PLINK interconnect of the MVP between input and output modules. Using the EO-5 paired with the OE-5, up to 5 PLINK interconnects can be transported over fiber up to 10Km with single mode fiber. The module is also used to convert optical GLINK signals from devices such as the 3000MVP-PPMG and the 7707RGBT-GF.

3.15.1. 3000MVP-EO-5 I/O Specifications

3.15.1.1. Video Input

Type:	Electrical PLINK/GLINK (Evertz Proprietary)
Number of Inputs:	5
Input Connector:	BNC per IEC 61169-8 Annex A
Impedance:	75 Ohms
Equalization (PLINK):	Automatic 10m Belden 1694 (equiv.)
Return Loss (PLINK):	> 15dB

3.15.1.2. Video Output

Type:	Optical PLINK/GLINK (Evertz Proprietary)
Connector:	Female SC/PC, ST/PC or FC/PC (SC/PC is standard)
Number:	5
Return Loss:	> 14 dB
Rise and Fall Time:	200 ps nominal
Fiber Size:	9 μm core / 125 μm overall
Wavelength:	1310nm (nominal)
Output Power:	-7dBm ± 1dBm

3.15.2. 3000MVP-OE-5 I/O Specifications

3.15.2.1. Video Input

Type:	Optical PLINK/GLINK (Evertz Proprietary)
Number of Inputs:	5
Connector:	Female SC/PC, ST/PC or FC/PC (SC/PC is standard)
Receive Sensitivity:	-24dBm

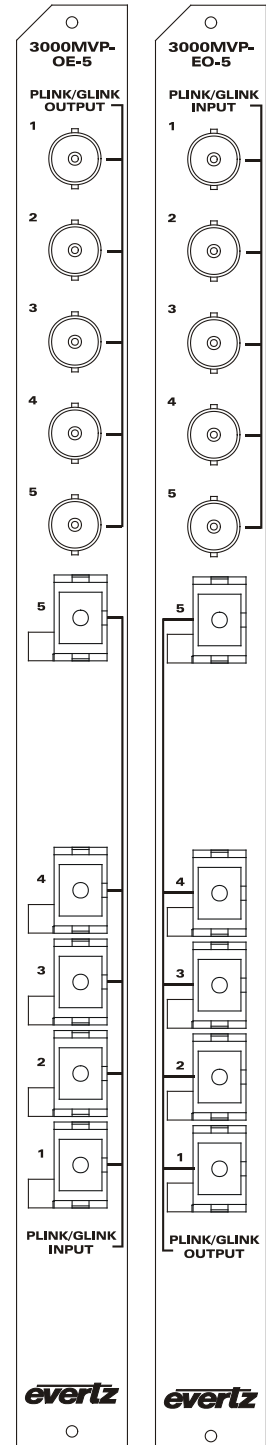

3.15.2.2. Video Output

Type: Electrical PLINK/GLINK (Evertz Proprietary)
Number of Outputs: 5
Connector: BNC per IEC 61169-8 Annex A
Impedance: 75 Ohms

3.15.3. Electrical

Voltage: +12V DC
Power: 10 W
EMI/RFI: Complies with FCC Part 15, Class A, EU EMC Directive

3.15.4. Ordering Information

3000MVP-EO-5 5 input PLINK/GLINK electrical to optical converter
3000MVP-OE-5 5 input PLINK/GLINK optical to electrical converter
Ordering Option: None

3.16. 3000DCP

The 3000DCP desktop control panel, provides an easy to use interface to the MVP for recalling presets and performing on display window selection. The 3000DCP allows for the simple recall of up to 20 presets per display to a total of 20 displays. Multi-purpose buttons allow the user to program specific functions into the DCP. Functions such as salvo recalls of the entire walls or “emergency” display fail over conditions. The shaft encoder and direction buttons allow for on screen selection. Remote connection of the DCP is provided via Ethernet, the panel can be placed anywhere in the facility provided it is on the same Ethernet network as the MVP. Interactive dot matrix display allows for simple feedback from the DCP when performing operations.



3.16.1. Specifications:

3.16.1.1. Physical

Dimensions: 10.2" w x 6.5" h x 2.6" t
Weight: 2lbs (902g)

3.16.1.2. Operational

Display buttons: 10 (+10 with shift)
Preset buttons: 10 (+10 with shift)
Multi-purpose buttons: 7

3.16.1.3. Communications

Ethernet Interface: RJ-45 connector

3.16.1.4. Electrical

Voltage: 12 VDC Nominal
Auto-ranging 100 to 240 VAC 50/60 Hz power adapter included
Power: 30 watts
EMI/RFI: Complies with FCC Part 15, Class A, EU EMC Directive

3.17. GENERAL PURPOSE INPUTS AND OUTPUTS (VIA DISPLAY MODULES)

GPI interfacing with the MVP is possible through general-purpose inputs and outputs available on each of the output display modules (on the dual SCSI connector). The display modules are shipped with 3000BHP-AUX breakout panels that are connected using the SCSI cable provided. The GPIs are active low with internal pullup resistors (4.7k Ohms) to +5 V. To make an input active, lower the signal to near ground potential (i.e. connect to shell or chassis ground). This can be done with a switch, relay, TTL drive, GPO output, or using another similar method. Figure 3-3 shows the input circuit for the general-purpose inputs. Figure 3-5 shows an example of how to interface the MVP GPI inputs to higher voltage systems.

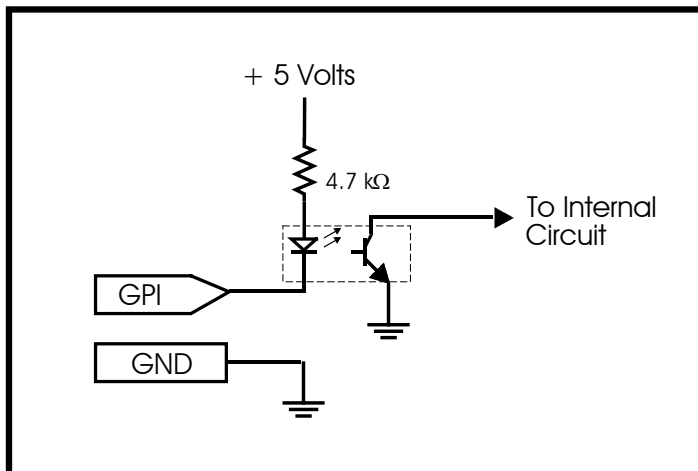

Figure 3-3: GPI Input Circuitry

The GPO's are active low with internal pull up (10kΩ) resistors to +5V. When the output goes low it is able to sink up to 10mA. When high, the signal will go high (+5V). **Do not draw more than 100μA from the output.** Figure 3-4 shows the circuit for the general-purpose output.

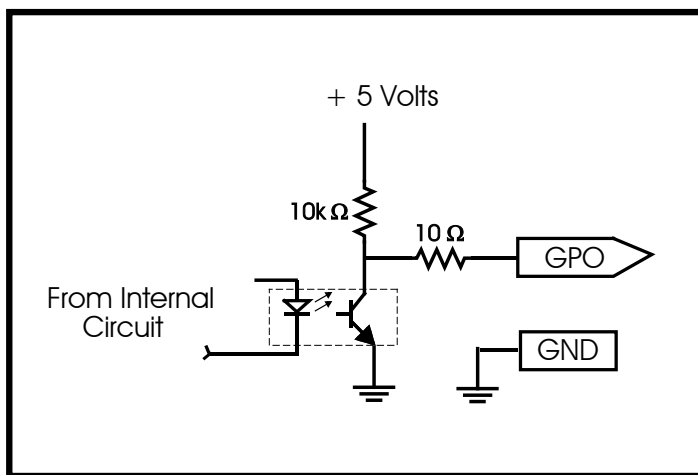

Figure 3-4: GPO Output Circuitry

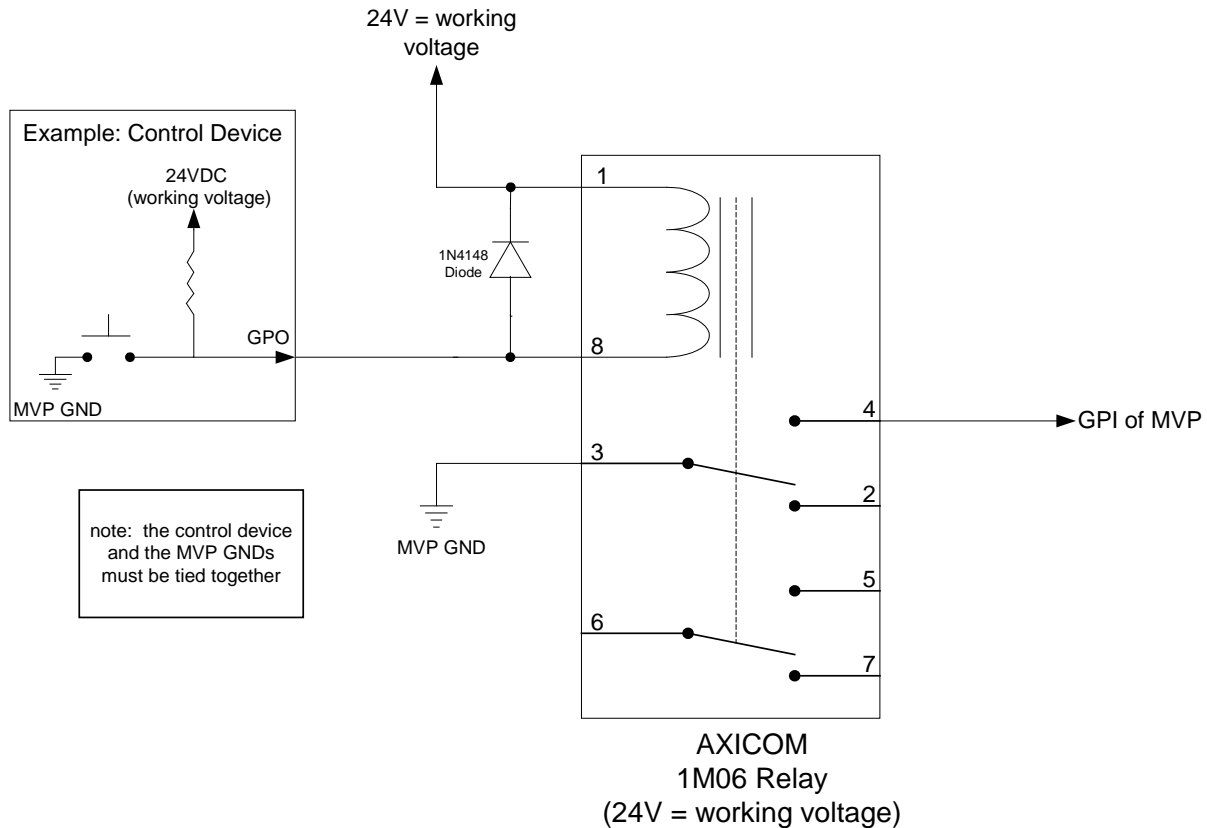

Figure 3-5: Interfacing GPIs to a High Voltage GPI System

3.18. SERIAL INTERFACE (VIA OUTPUT MODULES)

External serial communication with the MVP is possible through built-in RS-232/RS-422 ports available on each of the output display modules (on the dual SCSI connector). The display modules are shipped with 3000BHP-AUX breakout panels that are connected using the SCSI cable provided. See section 3.22.4 for more information on using the 3000BHP-AUX breakout panels. Typically, the user can drive 1000 ft on an RS-422 run.

To configure and module for a particular serial protocol, see the table in section 3.19.

3.18.1. RS-232 Mode

- Point-to-point connection - one driver, one receiver
- Two wires plus GND, max cable length 50 ft

Set J34 and J33 (on the PPV module) to the 232 position.

Connect the serial port on the 3000BHP-AUX terminal block J3 as follows:

RX --> data into MVP (RX)
TX --> data out from MVP (TX)
CTS --> not connected
RTS --> not connected

3.18.2. RS-422 Mode

- Multi-point connection - supports one driver and 10 receivers
- Must be terminated with 100 ohm resistor at one end
- Four wires plus shield, max cable length 3600 ft

Set J34 and J33 (on the PPV module) to 422 position.

Connect the serial port on the 3000BHP-AUX terminal block J3 as follows:

RX --> data into MVP (RX-)
CTS --> data into MVP (RX+)
TX --> data out from MVP (TX-)
RTS --> data out from MVP (TX+)

3.19. 3000MVP-PPV-X SCSI A AND SCSI B PIN ASSIGNMENT TABLE

SCSI Pin #	Signal	SCSI Pin #	Signal	SCSI Pin #	Signal	SCSI Pin #	Signal
A1	GND	A35	GPO 1	B1	GND	B35	GPO 23
A2	GND	A36	GPO 2	B2	GND	B36	GPO 24
A3	GPI 1	A37	GPO 3	B3	GPI 33	B37	GPO 25
A4	GPI 2	A38	GPO 4	B4	GPI 34	B38	GPO 26
A5	GPI 3	A39	GPO 5	B5	GPI 35	B39	GPO 27
A6	GPI 4	A40	GPO 6	B6	GPI 36	B40	GPO 28
A7	GPI 5	A41	GPO 7	B7	GPI 37	B41	GPO 29
A8	GPI 6	A42	GPO 8	B8	GPI 38	B42	GPO 30
A9	GPI 7	A43	GPO 9	B9	GPI 39	B43	GPO 31
A10	GPI 8	A44	GPO 10	B10	GPI 40	B44	GPO 32
A11	GPI 9	A45	GPO 11	B11	GPI 41	B45	GPO 33
A12	GPI 10	A46	GPO 12	B12	GPI 42	B46	GPO 34
A13	GPI 11	A47	GPO 13	B13	GPI 43	B47	GPO 35
A14	GPI 12	A48	GPO 14	B14	GPI 44	B48	GPO 36
A15	GPI 13	A49	GPO 15	B15	GPI 45	B49	GPO 37
A16	GPI 14	A50	GPO 16	B16	GPI 46	B50	GPO 38
A17	GPI 15	A51	GPO 17	B17	GPI 47	B51	GPO 39
A18	GPI 16	A52	GPO 18	B18	GPI 48	B52	GPO 40
A19	GPI 17	A53	GPO 19	B19	GPI 49	B53	GPO 41
A20	GPI 18	A54	GPO 20	B20	GPI 50	B54	GPO 42
A21	GPI 19	A55	GPO 21	B21	GPI 51	B55	GPO 43
A22	GPI 20	A56	GPO 22	B22	GPI 52	B56	GPO 44
A23	GPI 21	A57	AES OUT 1	B23	GPI 53	B57	GPO 45
A24	GPI 22	A58	AES OUT 2	B24	GPI 54	B58	GPO 46
A25	GPI 23	A59	AES OUT 3	B25	GPI 55	B59	GPO 47
A26	GPI 24	A60	AES OUT 4	B26	GPI 56	B60	GPO 48
A27	GPI 25	A61	RX1	B27	GPI 57	B61	RX2
A28	GPI 26	A62	TX1	B28	GPI 58	B62	TX2
A29	GPI 27	A63	CTS1	B29	GPI 59	B63	CTS2
A30	GPI 28	A64	RTS1	B30	GPI 60	B64	RTS2
A31	GPI 29	A65	LTC 1 IN +	B31	GPI 61	B65	LTC 2 IN +
A32	GPI 30	A66	LTC 1 IN -	B32	GPI 62	B66	LTC 2 IN -
A33	GPI 31	A67	GND	B33	GPI 63	B67	GND
A34	GPI 32	A68	GND	B34	GPI 64	B68	GND

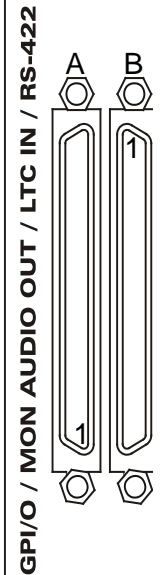

3.20. MVP™ BREAK-OUT I/O PANELS

- Audio Breakout Panels:** 3000BHP-U
3000BHP-BAL
- Dual Video Breakout Cable:** WP3000BHPDVIO
- Auxiliary Breakout Panel:** 3000BHP-AUX
- BHP Mounting Kit:** 3000MKT-BHP

**3.20.1. 3000BHP-U
(Option Included with AI modules - Identified as 3000MVP-AI+BHPU)**

The 3000BHP-U Bulkhead Breakout Panel is a 1RU panel equipped with 32 BNC inputs to accommodate up to 32 AES/EBU audio sources. Each panel ships with a single SCSI cable that is used to link it to the rear plate of either of the 3000MVP-AI modules.

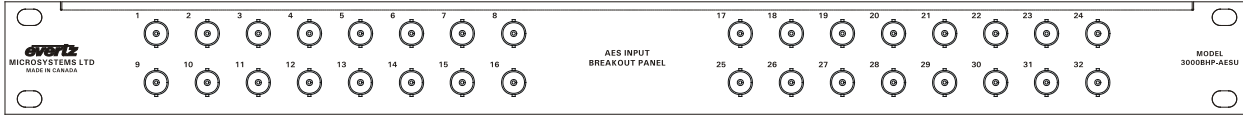

**3.20.2. 3000BHP-BAL
(Option Included with AI Modules - Identified as 3000MVP-AI+BHPBAL)**

The 3000BHP-BAL Bulkhead Breakout Panel is a 2RU panel equipped with 34 terminal block (1x6) connectors to accommodate up to 64 balanced analog audio inputs. Each panel ships with a two SCSI cables that are used to link it to the rear plate of either of the 3000MVP-AI modules.

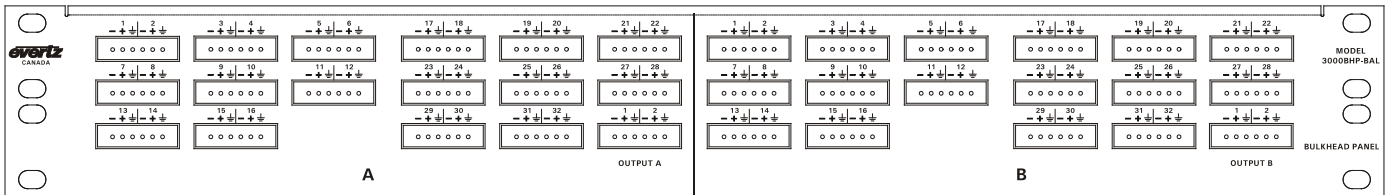

An audio connection diagram is provided in a subsequent section of this manual for balanced analog audio and AES/EBU inputs as well as unbalanced AES/EBU.

3.20.3. WP3000BHPDVIO CABLE (PPV9+D, PPMV)



Figure 3-6: WP3000BHPDVIO Breakout Cable

The WP3000BHPDVIO break out cable replaces the 3000BHP-DVIO breakout module. This cable provides the user with a break-out solution to display 2 separate monitors via DVI from a dual DVI source output of the PPV+D or PPMV/G module.

3.20.4. 3000BHP-AUX (Included with all PPV and PPMV Display Card Modules)

The 3000BHP-AUX provides the user with a breakout solution for auxiliary inputs and outputs including GPI/GPO, monitoring audio outputs, LTC inputs and serial communication lines. The interconnection between the BHP and the rear plate are SCSI connectors, with the input to BHP shown in the “Bottom View” picture below. One 3000BHP-AUX is used per SCSI cable. The functions of the pins for J1 and J2 change depending on whether the 3000BHP-AUX is connected to SCSI connector A or B. Connector J3 is only connected on the panel connected to SCSI connector A. There is a place on the 3000BHP-AUX silkscreen for you to identify which SCSI connector the panel is connected to.

The GPI inputs require a contact closure to activate them. The GPI outputs (GPO) are open collectors and sink current when active. There is a GPO bias voltage available on the Vext pin.



The Vext pin is to be used as a pull-up bias for the general-purpose outputs only. The Vext pin cannot supply enough current to power any external devices.

User can identify which SCSI connector the 3000BHP-AUX is connected to.

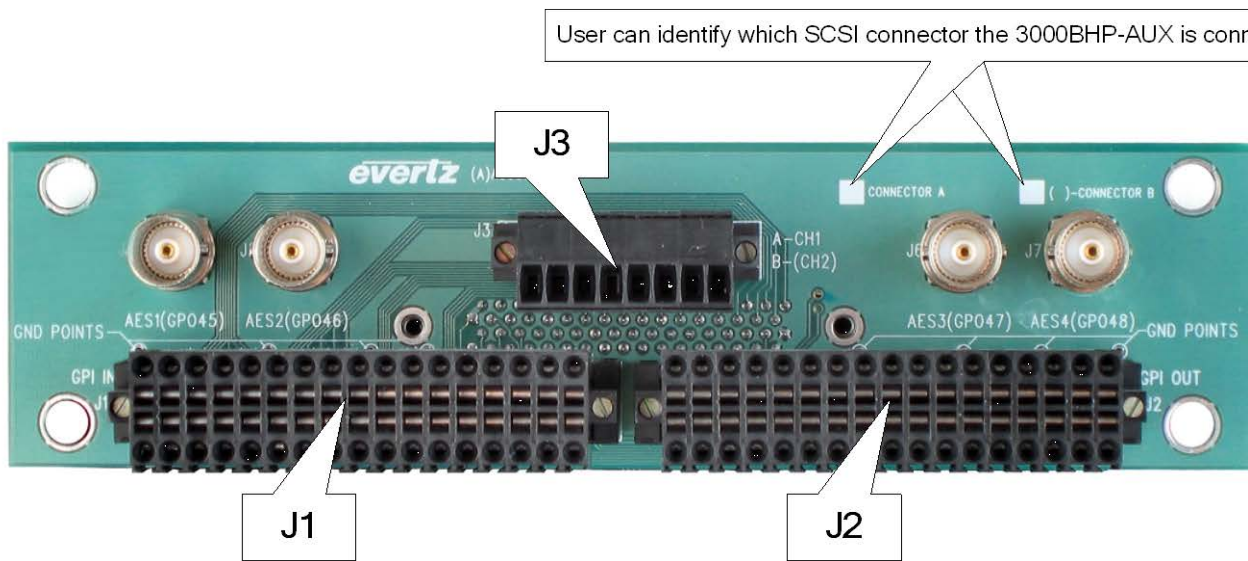

Figure 3-7: Top View

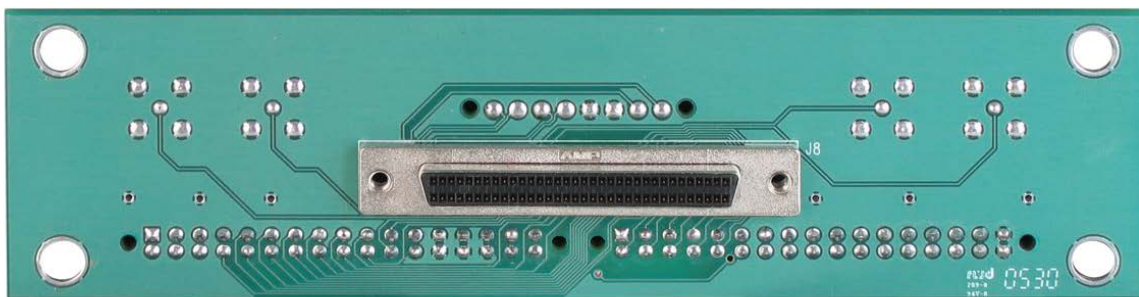

Figure 3-8: Bottom View (to PPV-x Module via SCSI Cable, Factory-Provided)

The various GPI/GPO connections are displayed below for configuration with a single 3000BHP-AUX (Connector A) and with two 3000BHP-AUX breakouts (Connector A and Connector B).

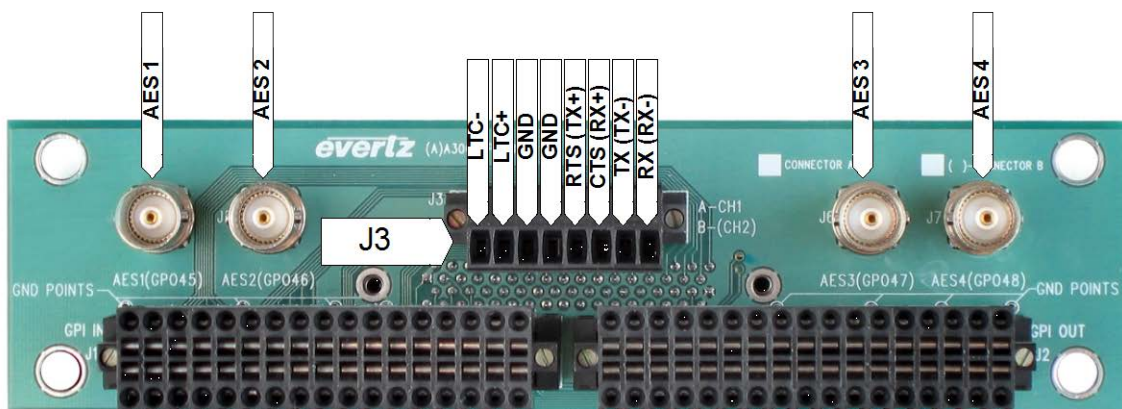

Figure 3-9: AES, LTC and Serial Data Ports (Connected to PPV-x Module SCSI A)

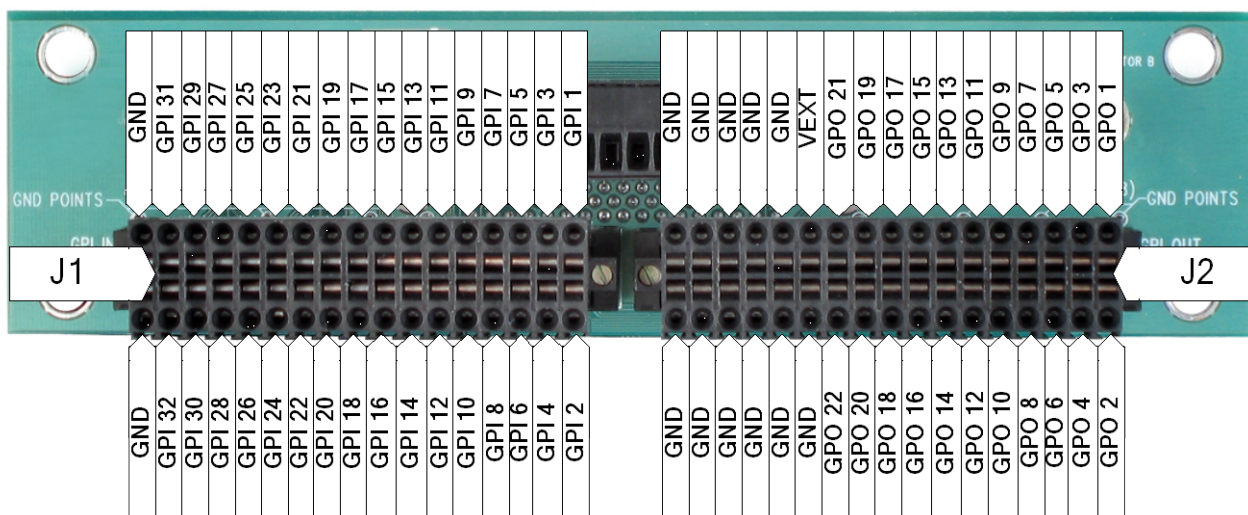

Figure 3-10: GPIO Connections when Connected to PPV-x Module SCSI A

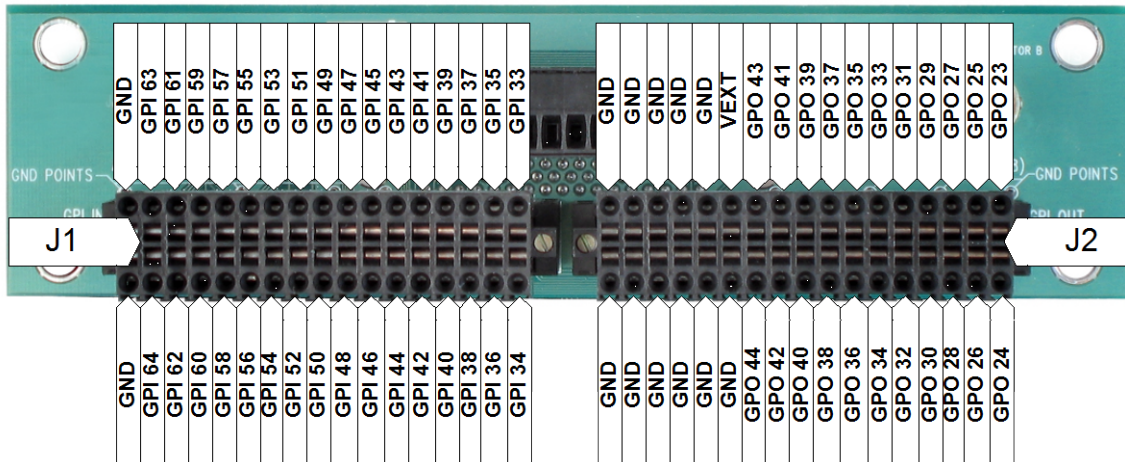

Figure 3-11: GPIO Connections when Connected to PPV-x Module SCSI B

3.20.5. 3000MKT-AUX Breakout Panel Mounting Kit

For mounting convenience, a breakout panel mounting kit is available with mounting hardware. It is shown in the picture below with two BHPs. This ships standard with all MVP display cards.

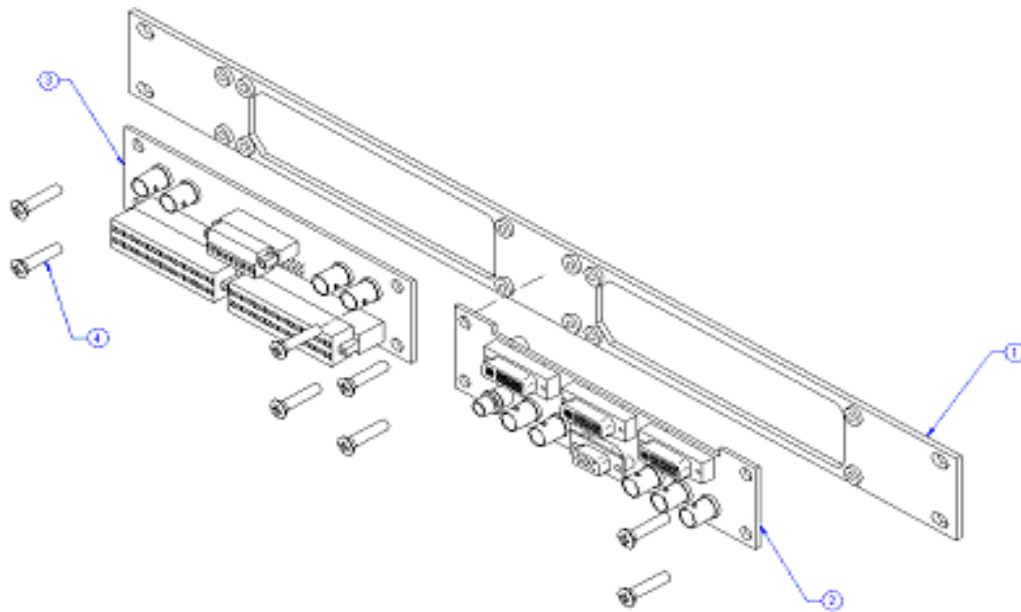

Figure 3-12: Mounting Breakout Panels Using the 3000MKT-AUX Breakout Panel Mounting Kit

4. MVP™ NETWORK CONFIGURATION

4.1.1. Part 1: Making the Network Connections

The MVP™ requires only a single network connection via good quality, straight-thru Ethernet cable, terminated at both ends with RJ-45 male connectors, as shown in Figure 4-1.

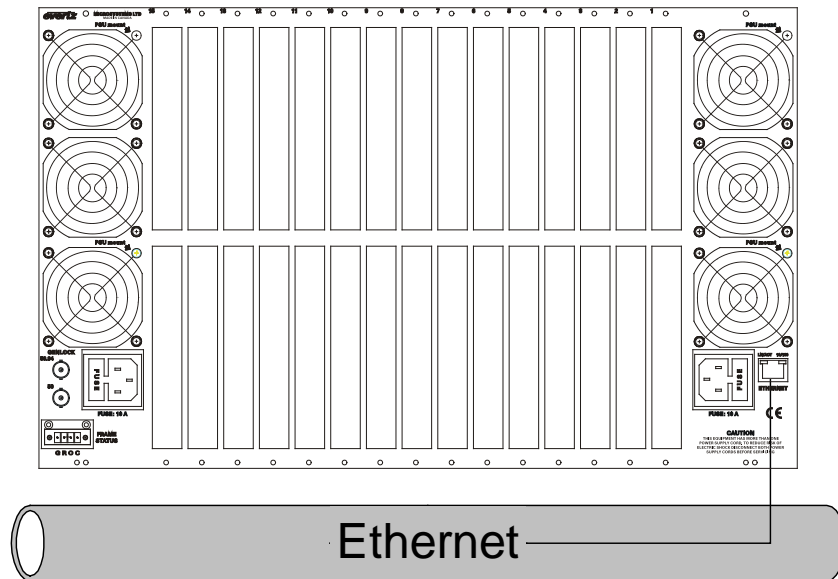
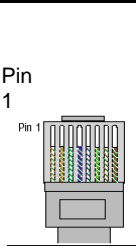

Figure 4-1: Making the Ethernet Connection

The MVP™ is designed to be used with either 10Base-T (10 Mbps) or 100Base-TX (100 Mbps) also known as *Fast Ethernet*, twisted pair Ethernet cabling systems. When connecting for 10Base-T systems, category 3, 4, or 5 UTP cable as well as EIA/TIA – 568 100Ω STP cable may be used. When connecting for 100Base-TX systems, category 5 UTP cable is required. The cable must be straight-through, with an RJ-45 connector at each end. Make the network connection by plugging one end of the cable into the RJ-45 receptacle of the MVP Frame and the other end into a port of the supporting switch. If only connecting a single PC to one MVP frame, a single crossover or straight-through network connection will work. If more network elements exist, an external network switch will be required.

The straight-through RJ-45 cable can be purchased or can be constructed using the pinout information in Table 4-1. A colour-code wiring table is provided in Table 4-1 for the current RJ 45 standards (AT&T 258A or EIA/TIA 258B colour coding included). Also refer to the notes following the table for additional wiring guide information.



Pin #	Signal	EIA/TIA 568A	AT&T 258A or EIA/TIA 568B	10BaseT or 100BaseT
1	Transmit +	White/Green	White/Orange	X
2	Transmit –	Green/White or White	Orange/White or Orange	X
3	Receive +	White/Orange	White/Green	X
4	N/A	Blue/White or Blue	Blue/White or Blue	Not used (required)
5	N/A	White/Blue	White/Blue	Not used (required)
6	Receive –	Orange/White or Orange	Green/White or Green	X
7	N/A	White/Brown	White/Brown	Not used (required)
8	N/A	Brown/White or Brown	Brown/White or Brown	Not used (required)

Table 4-1: Standard RJ45 Wiring Colour Codes

Note the following cabling information for this wiring guide:

- Only two pairs of wires are used in the 8-pin RJ-45 connector to carry Ethernet signals.
- Even though pins 4, 5, 7 and 8 are not used, it is mandatory that they be present in the cable.
- 10BaseT and 100BaseT use the same pins; a crossover cable made for one will also work with the other.
- Pairs may be solid colours instead of striped.
- Category 5 cables must use Category 5-rated connectors.

The maximum cable run between the MVP™ and the supporting hub is 300 ft (90 m). The maximum combined cable run between any two end points (i.e. MVP™ and PC/laptop via network hub) is 675 feet (205 m).

Devices on the Ethernet network continually monitor the receive data path for activity as a means of checking that the link is working correctly. When the network is idle, the devices also send a link test signal to one another to verify link integrity. The MVP network connection port is fitted with two LEDs to monitor the Ethernet connection.

10/100: This LED is ON when a 100Base-TX link is last detected. The LED is OFF when a 10Base-T link is last detected (the LINK LED is ON). Upon power-up the LED is OFF as the last detected rate is unknown and therefore defaults to the 10Base-T state until rate detection is complete.

LN/ACT: This dual purpose, green LED indicates that the MVP module has established a valid link to its hub, and whether the MVP module is sending or receiving data. This LED will be ON when the MVP module has established a good link to its supporting hub. This indicates that the segment is wired correctly. The LED will BLINK when the MVP module is sending or receiving data. The LED will be OFF if there isn't a valid connection.

4.1.2. Part 2: Connecting Serial Communications to the MVP Modules

MVPs are shipped with an Evertz standard “PB Upgrade” cable (part number WA-S76). Connect the computer to the card edge serial port by placing the 7700PB serial upgrade cable to the 2x3 header of a module. On video input modules (OV-x and GI-x), the header is located next to the front card-edge between the LEDs and the toggle switch (for example, J4 on the OV and GI modules – see Figure 1 of this section). On PPV-x modules, J13 is located near the front card-edge (Figure 2 of this section - black). On older video output modules, header J13 is located toward the lower middle portion of the main board (Figure 2 of this section - grey).

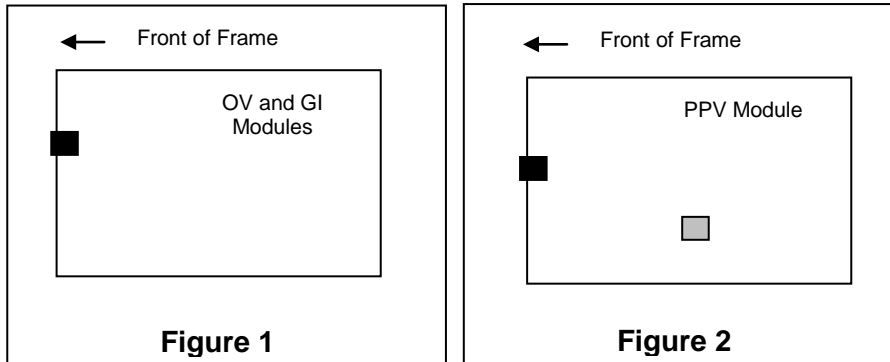

Note that pins 1 and 5 on the header should be removed, and pins 1 and 5 on the cable connector should also be plugged. If the cable is not keyed, make sure that you install it so that the cable is away from the front of the frame when the module is installed (i.e. so that it passes over the full length of the card). Pin 1 of the ribbon cable is brown and will be facing the edge of the module with the card ejector when the cable is installed correctly.

7700FC End		PC End		
2 row X 3 pin Berg	Pin	6 Conductor Ribbon Cable	9 pin D Female	Pin
Key	1	Brown		1
Rx	2	Red	Tx	2
Tx	3	Orange	Rx	3
Tx Gnd	4	Yellow	Gnd	5
Key	5	Green		
---	6	Blue		

Table 4-2: 7700PB Upgrade Cable (WA-S76)

4.1.3. Part 3: Terminal Program Setup

1. Start the terminal program and configure the port settings of the terminal program for the OV, GI and PPV modules as follows:

Baud	115200
Data bits	8
Parity	None
Stop bits	2
Flow Control	None

2. The port settings of the terminal program for the AI and FC modules are as follows:

Baud	57600
Data bits	8
Parity	None
Stop bits	2
Flow Control	None

3. Install the cable onto the jumper of the module, and then slide the module into the frame.

4.1.4. Part 4: Setting IP Addresses on MVP Modules

Every MVP input (OV and GI) module and output (PPV) module is shipped with a factory assigned IP address. These IP addresses are listed on a table and included with every frame (paper copy, usually attached to the frame lid). If a particular card is not included in this frame, it is removed from the table. Alternatively, if a new card is added to this frame, its type and IP address is also added to this table. The generic IP address sheet per frame appears as follows:

Module	Pre-assigned IP address				Slot #
3000FC	192	168	9	1	
3000MVP-PPV	192	168	9	2	
3000MVP-OV	192	168	9	3	
3000MVP-OV	192	168	9	4	
3000MVP-OV	192	168	9	5	
3000MVP-OV	192	168	9	6	
3000MVP-OV	192	168	9	7	
3000MVP-OV	192	168	9	8	
3000MVP-OV	192	168	9	9	
3000MVP-OV	192	168	9	10	
3000MVP-OV	192	168	9	11	
3000AI	192	168	9	12	
3000AI	192	168	9	13	
3000AI	192	168	9	14	
3000AI	192	168	9	15	
3000AI	192	168	9	16	

The IP addresses of each module have been pre-assigned to the values listed for testing purposes. You may leave them as they are or change them to better reflect your exact network topology. If you want to change the IP address, please follow the steps listed below.

4.1.4.1. Set the IP Address and Configure the “PPV” or “PPMx” Module

As described in Step 2 above, the upgrade cable is connected to jumper J13 and the PPV-x module and is re-seated into the frame. Once the frame is powered-up, the HyperTerminal connection displays boot-up status information and, once completed, ends with the **Main Menu** selection as shown below:

```

-----
|                                     |
|                               Main Menu |
|                            (3000PPV 2.8.2) |
|                                     |
|-----|
(1) Network Configuration
(2) Onboard Server Configuration
(3) Utilities
(4) Under Monitor Display Setup
(5) Auxiliary Serial Port Setup
(6) Display Wall Test
(7) Hardware Test Menu
(8) Engineering/Debug

(X) Exit

```

To open a menu item, type the corresponding number from the list, and then press <ENTER>. **Remember to SAVE when a change has been made before exiting the menu.**

Menu item (1) is the *Network Configuration*, in which you set the IP address properties for this output module.

```

-----
|                                     |
|                               Network Configuration |
|                            (3000PPV 2.8.2) |
|                                     |
|-----|
ENET: 0  MAC: 00:02:c5:fe:b1:25

ip address:          192.168.0.14
netmask address:    255.255.255.0
gateway:            0.0.0.0
broadcast address: 192.168.0.255
DHCP enabled: False
-----
(1) Set IP Address
(2) Set Netmask
(3) Set Gateway
(4) Set Broadcast Address
(5) Use DHCP

(S) Save and Exit
(X) Exit

```

In this menu, selecting options (1) through (4) allows the user to set the networking parameters of the PPV module. DHCP is not recommended, as control of the MVP requires static IP addresses. Once you have configured the IP, save and exit this menu by selecting “S”. All modules ship with DHCP disabled (or DHCP enabled set to “FALSE”). If you are not sure whether you should use this option, contact your networking/IT administrator.

Once you have returned to the Main Menu, select option **(2) Onboard Server Configuration**, and then select **(1) Display Connection Status** to see what input and output modules are configured and connected. Configuration is not possible in this menu option; it is simply a connection status summary.



Note: This option is only applicable for non PC-based MVP systems.

```

-----
|                                     |
|               Onboard Server Configuration               |
|               (3000PPV 2.8.2)                           |
|-----|-----|
Onboard Server: Enabled
Onboard GPIId: Enabled
Onboard VGPIId: Disabled
Onboard DCPd: Enabled
Onboard SymphD: Disabled
-----

(1) Display connection status
(2) Enable server
(3) Enable gpid
(4) Enable vgpId
(5) Enable dcpd
(6) Enable symphd

(S) Save and Exit
(X) Exit

Name      IP              Status
-----|-----|-----
DC1       192.168.0.19      CONNECTED
DC2       192.168.0.22      CONNECTED
IC1       192.168.0.42      CONNECTED
IC2       192.168.0.43      CONNECTED
IC3       192.168.0.44      CONNECTED
IC4       192.168.0.45      CONNECTED
IC5       192.168.0.46      CONNECTED
IC6       192.168.0.47      CONNECTED
IC7       192.168.0.49      CONNECTED
IC8       192.168.0.50      CONNECTED
IC9       192.168.0.52      CONNECTED
IC10      192.168.0.53      CONNECTED
IC11      192.168.0.136     CONNECTED

```

Select option **(3) Utilities** if you wish to clear the system settings on this display module.

```

-----
|                                     |
|               Utilities                               |
|               (3000PPV 2.8.2)                           |
|-----|-----|
(1) Clear NV High Level (no system settings)
(2) Clear NV Low Level (clear entire flash)

(X) Exit

```

Select option **(4) Under Monitor Display Setup** if you want to configure the dynamic UMD interface to this output module. The source of information and type of protocol along with interconnect information is entered through this menu.

```
-----  
|                               |  
|           Under Monitor Display Setup           |  
|           (3000PPV 2.8.2)                       |  
|-----|  
  
Protocol:      Image Video  
Input Type:    network  
TCP Port:     9800  
-----  
  
(1) Set protocol  
  
(S) Save and Exit  
(X) Exit
```

Choosing **(1) Set Protocol** provides a list of protocols (as below) for you to select. Typing the corresponding number sets the protocol. Please refer to section 9 of this manual for further information on setting protocols.

```
Select UMD protocol:  
1. Image Video  
2. Philips ASCII  
3. XY Integrator  
4. TSL  
5. Echo  
(1-5) >
```

(5) Auxiliary Serial Port Setup – This menu option sets the output module's serial port attributes. These attributes must agree with those being presented from the interfacing box.

```
-----  
|                               |  
|           Auxiliary Serial Port Setup           |  
|           (3000PPV 2.8.2)                       |  
|-----|  
  
Baud Rate:    115200  
Data Bits:    8  
Parity:       None  
Stop Bits:    2  
-----  
  
(1) Set baud rate  
(2) Set number of data bits  
(3) Set parity  
(4) Set number of stop bits  
  
(S) Save and Exit  
(X) Exit
```

(6) Display Wall Test, (7) Hardware Test Menu, and (8) Engineering/Debug menu items are used by Evertz Service personnel only.

4.1.4.2. Set the IP Address and Configure the “OV” and/or “GI” Module

As described in Step 2 above, the upgrade cable is connected to jumper J4 and the module is re-seated into the frame. Once the frame is powered-up, the HyperTerminal connection displays boot code and, once completed, ends with the Main Menu selection.

```
-----  
|                               |  
|           Main Menu          |  
|       (3000OV 2.6.1 b6498)   |  
|                               |  
|-----|  
(1) Network Configuration  
(2) SNMP Configuration  
(3) Audio Configuration  
(4) Video Utilities  
(5) Global Card Utilities  
(6) Engineering Debug Utility  
  
(X) Exit
```

Select **(1) Network Configuration** to set the IP address of the specific OV module.

```
-----  
|                               |  
|       Network Configuration  |  
|       (3000OV 2.6.1 b6498)   |  
|                               |  
|-----|  
MAC: 00:02:c5:fe:ba:81  
  
ip address:      192.168.0.42  
netmask address: 255.255.255.0  
gateway:         0.0.0.0  
broadcast address: 192.168.0.255  
DHCP enabled: False  
-----  
(1) Set IP Address  
(2) Set Netmask  
(3) Set Gateway  
(4) Set Broadcast Address  
(5) Use DHCP  
  
(S) Save and Exit  
(X) Exit
```

Selecting menu option (1) sets the IP address of the card. Options (2) – (4) set the remaining networking parameters for this input module, while option (5) allows the user to have the DHCP-supported server automatically set a non-conflicting IP address for this module (not recommended). Option “S” saves the configuration and exits this menu.

Option (2) on the Main Menu sets the SNMP trap destination and for fault/TRAP monitoring from the OV modules.

```
-----  
|                               |  
|           SNMP Configuration |  
| (3000OV 2.6.1 b6498)       |  
|                               |  
-----
```

```
-----  
Trap Destination 1: 192.168.1.214  
-----
```

- (1) Set Trap IP Address
- (2) Remove Trap IP Address

- (S) Save and Exit
- (X) Exit

Options **(3) Audio Configuration**, and **(4) Video Utilities** are no longer used. The parameters within are now configured using the **System Configuration Tool**.



Please note that the Hide Softkey Code is not applicable in most applications.

Option **(5) Global Card Utilities** is an engineering tool and should not be accessed during regular set-up or operation.

Once changes are completed and the modules have saved (automatic upon exiting) new configurations, simply remove the serial connection and shutdown the HyperTerminal connection. The frame must then be power-cycled.

Configuration of the GI modules is very similar to that detailed above, with some slight variations.

```
-----  
|                               |  
|           Main Menu           |  
| (3000GI v2.6.0 b2209)       |  
|                               |  
-----
```

- (1) Network Configuration
- (2) SNMP Configuration
- (3) Audio Configuration
- (4) Video Utilities
- (5) Global Card Utilities
- (6) Engineering Debug Utility

- (X) Exit

Menu item **(2) SNMP Configuration** allows you to set or remove a Trap IP Address by selecting the corresponding number.

```
-----  
|                               |  
|           SNMP Configuration |  
| (3000GI v2.6.0 b2209)      |  
|                               |  
-----  
No Trap Destinations Assigned  
-----  
  
(1) Set Trap IP Address  
(2) Remove Trap IP Address  
  
(S) Save and Exit  
(X) Exit
```

Use **(4) Video Utilities** to set the size and position, as well as the gain and black level.

Cropping is set using the **Crop Setup** window in the **System Configuration Tool (Hardware Settings > Properties > Crop Setup)**. To use this feature:

1. Open the **System Configuration Tool**.
2. Click on the **Hardware Settings** Tab.
3. Highlight the appropriate Video Input.
4. Click **Properties**.
5. Click the **Crop Setup** tab.
6. Input the required crop values into the text fields.

```
-----  
|                               |  
|           Video Utilities    |  
| (3000GI v2.6.0 b2209)      |  
|                               |  
-----  
  
(1) Crop  
(2) Size and Position  
(3) Gain and Black Level  
  
(S) Save and Exit  
(X) Exit  
>
```

The **(5) Global Card Utilities** menu item is an engineering tool and should not be accessed during regular set-up or operation.

5. MAPPING DISCRETE AUDIO TO VIDEO INPUTS

This MVP™ chapter covers:

- Wiring discrete audio into a BHP
- Configuring the following modules to handle discrete audio (analog or digital AES/EBU) via the 3000MVP-AI (with associated BHP):
 - 3000MVP-OV-SN
 - 3000MVP-OV-HSN
 - 3000MVP-OV-SNX
 - 3000MVP-OV-N

Audio (balanced or unbalanced AES/EBU and balanced analog) is provided via the AI module through BHP panels and is wired based on the following diagrams (rear plate connections are all through right-side female SCSIs only).

Unbalanced AES Single ended 75Ω

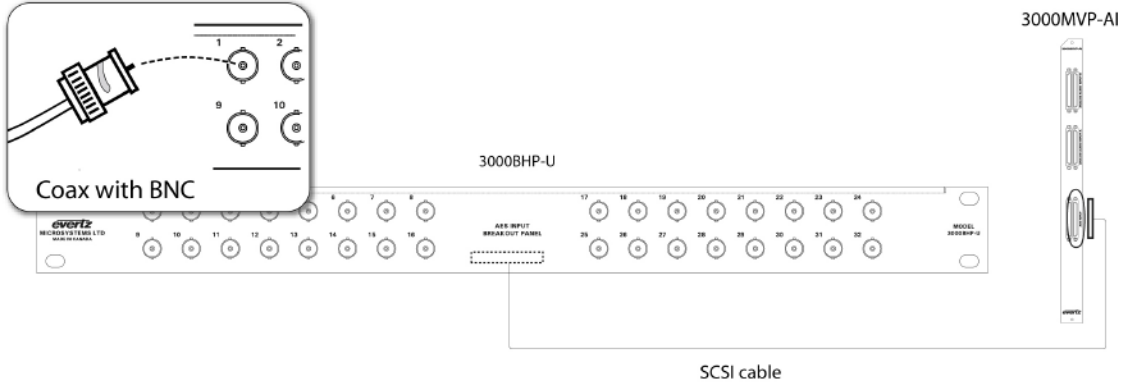

Balanced (110Ω) AES

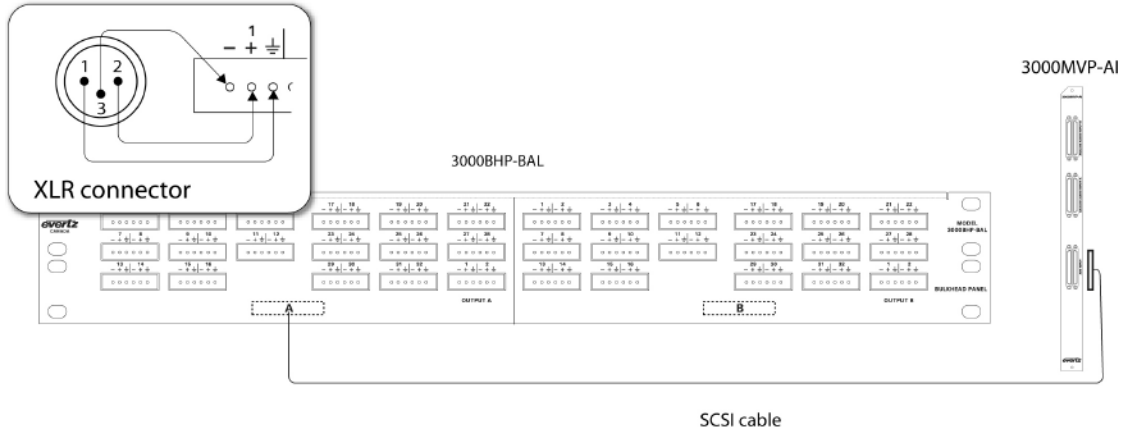

Balanced analog stereo pair

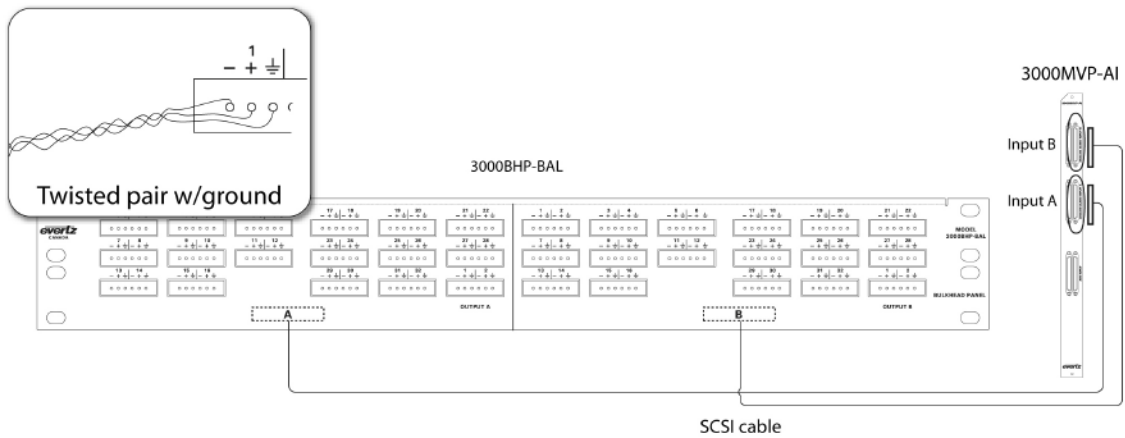

Discrete AI audio modules are positioned in the frame in the adjacent slot to an OV card. One AI module can support:

- A single OV module, and provide up to two groups of AES/EBU audio, or four pairs of analog audio per video input
- Two OV modules, and provide up to one group of AES/EBU audio, or two pairs of analog audio per video input

Note: In this case, the AI module must be positioned between two OV modules.

- Four OVs – a single AES (pair) of audio

Associating discrete audio inputs with video signals (a.k.a. audio mapping) takes place in the adjacent OV cards. Audio is mapped using the System Configuration Tool by following the procedure below:

1. Open the **System Configuration Tool**.
2. Click on the **Hardware Settings** tab.
3. Highlight the appropriate OV.
4. Click the **Properties** button.
5. Click the **Audio Setup** tab. This opens the window in Figure 5-1 below:

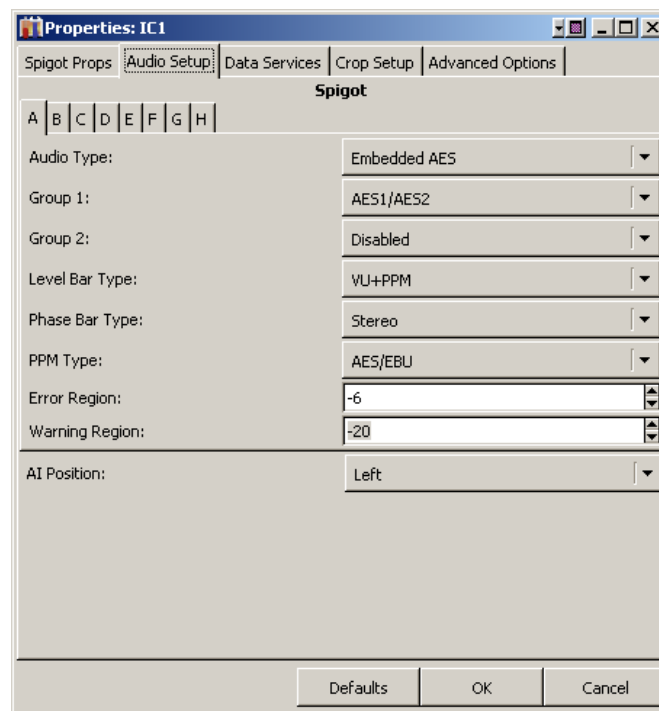

Figure 5-1: Audio Setup Window

6. Set the parameters described below as required for your particular application.

5.1. AUDIO MENU ITEMS

Audio Type:

This menu option allows you to choose between the following audio types: Discrete Unbalanced AES, Discrete Balanced Analog, Embedded AES, or Discrete Balanced AES.

Group 1:

Selects which pairs of audio (e.g.: AES1/AES2) will be assigned to Group 1.

Group 2:

Selects which pairs of audio (e.g.: AES1/AES2) will be assigned to Group 2. This group can also be disabled.

Level Bar Type:

In this menu option, you can choose VU + PPM, or PPM level bar types. The VU + PPM option displays both an average audio level indicated by a solid bar, and peak average audio indicated by a white marker.

Phase Bar Type:

This setting allows you to choose between Stereo and DIN.

PPM Type:

Offers different standards for audio level scales.

Error Region:

Set this parameter to determine what audio level will be considered an error.

Warning Region:

Set this parameter to determine what audio level will be considered a warning. Please note that when using analog audio, the Warning Region is synonymous with the Reference, even though the field label does not change.

AI Position:

Use this parameter to set the AI module's position in the frame (either left or right) relative to the OV module.

6. MODULE UPGRADES

There are two primary upgrade processes available to the user: File Transfer Protocol (FTP) and Serial Upload. Both are described below for specific I/O modules.

6.1. NETWORKING FUNDAMENTALS (FTP UPGRADE PROCESS)

Before any FTP (file transfer protocol) upgrades can be initiated:

- Modules must be pre-configured with IP addresses (see section 2.3 and 4).
- The user must determine the IP address of the PC/laptop.
- All nodes must be on the same subnet for the FTP upgrade to work properly.

This process is used with “OV”, “GI” and “PPV” modules, but will not work with the 3000FC and 3000MVP-AI modules. For the latter products, please refer to the product-specific section for upgrade details.

To check if a proper network connection has been established:

1. Connect the network cable from the PC/laptop to the MVP frame.
2. Open a Command Prompt window (**Start > Programs > Accessories > Command Prompt**) on the PC/laptop.
3. Ping the IP address of the module being upgraded. For example:

```
C:\ ping 192.168.9.100 <Enter>
```

If a proper network connection has been established, a “reply” is displayed on the DOS window.

If the network connection is faulty, a “Destination Host Unreachable” message is provided. This means that either the IP addresses of the nodes should be verified or the network (Ethernet) cable is faulty. For more information, please see section 2.3 and 4 of this manual.

6.2. UPGRADING THE APPLICATION CODE

The following instructions outline the process required to upgrade the application code for the modules listed below:

3000MVP-PPV-5/9+D	3000MVP-GO
3000MVP-PPV-5/9	3000MVP-OV-SN/HSN
3000MVP-GI-2/4	3000FC
3000MVP-AI	3000MVP-PPR-12x10
3000MVP-PPMV/G	3000MVP-PPR-16x16
3000MVP-VGO	3000DCP

For any modules not listed above, please contact your Evertz representative for further upgrade instructions.

Prior to initiating the upgrade process, confirm the version of code currently installed on the module by examining the card-edge LED. The version information is cycled regularly and frequently on this display. If necessary, press the push-button to start the display process.

Also, prior to starting the upgrade:

- Verify that there is new application code to upgrade by contacting your Evertz representative.



Note: Be sure to ask for a list of new features provided in the upgrade.

- Verify that you have the correct firmware for the right card (i.e.: that the firmware you are installing is meant to be used with this card).

There are three upgrade processes available to the user for the list of modules below: File Transfer Protocol (FTP), Serial Upload, and the System Configuration GUI software. Both FTP and Serial Upgrade methods are described below for specified **Video I/O** modules. See the System Configuration tool section for instructions on using the GUI for upgrades. Using the System Configuration tool is the recommended method.

3000MVP-OV-SN
3000MVP-OV-SNX
3000MVP-OV-HSN
3000MVP-GI-2
3000MVP-GI-4
3000MVP-PPV-5
3000MVP-PPV-9
3000MVP-PPV-5+D
3000MVP-PPV-9+D
3000MVP-PPMV/13
3000MVP-PPMG/13
3000MVP-PPMX13/16

6.2.1. VIDEO I/O FTP Upgrade Method

1. Identify and confirm the IP addresses of the module and PC/laptop, and ensure that they are on the same subnet.
2. Power on the MVP system with the module installed in the MVP frame.
3. Obtain the new application code from the FTP site and place it on the PC's local drive.
4. Open a DOS window by selecting **Start > Run**, and typing "cmd" in the window that appears, as shown in Figure 6-1.

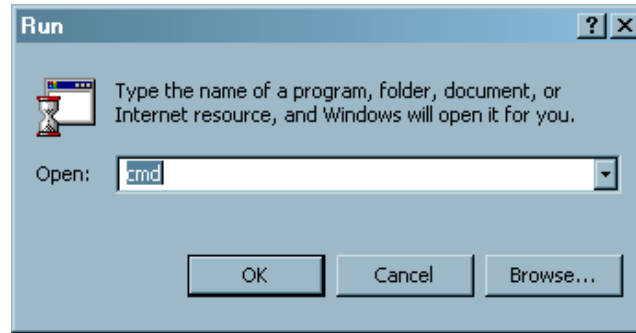

Figure 6-1: Run Window

5. In the DOS window type: *ftp xxx.xxx.xxx.xxx* (where the x's represent the module's IP address).
6. Press <ENTER> when prompted for a "Username", and again when prompted for a "Password".
7. At the "FTP>" prompt, type "quote site upgrade".
8. At the "FTP>" prompt, type "put x.bin", where x represents the name of the application (.bin) file.



Note: If the application file is not local to where you are performing the FTP, then include the path with the name:

(e.g.: "put c:\mvp\lov\app\3000OV_180903.bin")

9. A message indicating the successful connection to the module is displayed.
10. At this time, the card-edge will show a "% complete" value, indicating that the card is now uploading the new code. During this time it is mandatory that all power cycles of the module or frame be avoided.

Upon completion, the input modules will enable a small red LED on the card-edge indicating that the transfer was successful, and that the module is waiting for a power cycle before the new code will take effect.



Note: The display card does not have this feature.

After upgrading any PPV-x module, **it is important to clear display memory before new code takes effect.** This can be done as follows:

1. On the PPV-x card edge, lift dip switches 2, 3, and 4 to the "up" position.
2. Power cycle the PPV.
3. Wait approximately 30 seconds after power cycling, then put dip switches 2, 3, and 4 back down to their default position.

4. Power cycle the card again.

6.2.2. VIDEO I/O Serial Upload Method

This method transfers the new application code via the upgrade serial port on the front edge of the module.

1. Turn off the MVP frame containing the module that is to be upgraded.
2. Connect the factory-supplied 7700PB serial upgrade cable to J4 on the front edge of the OV card, and connect the other end of this cable to a serial port on a PC with a serial terminal program.

Note: Jumper J13 on PPV-x modules.

3. Place a jumper across pins 2 and 3 on J12 (“Upgrade” mode).

Note: Jumper J5 on PPV-x modules.

4. Set up the serial communication properties for the COM port (see section 4.1.3 to obtain serial port settings for a specific module).
5. Power on the MVP frame with the module installed.

When the module boots-up, “PPCBOOT>” is displayed on the terminal screen.

6. At the prompt type “upload”, then press <ENTER>.

The following message will be displayed:

Upload product firmware now

7. Upload the application code by using the *send file* function in the terminal software. When prompted, use the “Xmodem” protocol for data transfer.

When the transfer is complete (which can take up to 30 minutes or more) the terminal will return to the PPCBOOT prompt. You should:

1. Turn off the MVP frame.
2. Remove the module from the MVP frame and remove the upgrade serial cable.
3. Place a jumper across pins 1 and 2 on J12 (“Run” mode).

Note: J5 on PPV-x modules

4. Re-insert the module into the MVP frame.

6.2.3. Upgrading 3000FC Application Code

The 3000FC is upgraded via the configuration serial port (J7) near the front edge of the card.

1. Turn off the MVP frame with the FC card that is to be upgraded.
2. Connect the 7700PB serial upgrade cable supplied with the MVP frame to the J7 on the front edge of the FC card and connect the other end of this cable to a serial port on a PC with a serial terminal program.
3. Place a jumper across pins 1 and 2 on J7 (“Upgrade Mode”).
4. Set up the serial communication properties for the COM port as follows:

COM:	Select the COM port
Bits per second:	57600
Data bits:	8
Parity:	None
Stop bits:	2
Flow control:	None

5. Power on the MVP frame with the FC card installed.
6. When the FC card boots up, the following information will be printed on the terminal screen:

```
EVERTZ MCF5272 MONITOR 2.3 BUILD 3 (66 MHZ)
COPYRIGHT 1997, 1998, 1999, 2000, 2001, 2002 EVERTZ MICROSYSTEMS LTD.
28F160C3B FLASH DETECTED
BRD=3000FC
MODEL=BA3000FC
PROD=3000FC
FRAME=3000FR
UPGRADE JUMPER INSTALLED

UPLOAD FILE NOW, CONTROL-X TO CANCEL
```

7. To upload the FC with the new application code, use the *send file* function in the terminal software.



Note: If prompted, use the “Xmodem” protocol for data transfer.

The download can take up to 5 minutes to complete, a message will indicate that the upload is “OKAY”.
Execute the following steps when the download is complete:

1. Power down the MVP frame.
2. Remove the FC card from the frame.
3. Disconnect the upgrade serial cable, and place a jumper across pins 2 and 3 on J7.

4. Insert the FC card back into the MVP frame and power up the MVP frame.

6.2.4. Upgrading 3000MVP-AI, 3000MVP-VGO, 3000MVP-GO, 3000MVP-PPR Application Code

The 3000MVP-AI, VOG, GO, PPR are upgraded via the configuration serial port (J51) near the front edge of the card. The 3000MVP-AI card is used as an example for the upgrade procedure.

1. Turn off the MVP frame with the AI card that is to be upgraded.
2. Connect the 7700 serial upgrade cable supplied with the MVP frame to J51 on the front edge of the AI card, and connect the other end of this cable to a serial port on a PC with a serial terminal program.
3. Place a jumper across pins 2 and 3 on J49 ("Upgrade mode").
4. Set up the serial communication properties for the COM port as follows:

COM:	Select the COM port that the serial cable is connected to.
Bits per second:	57600
Data bits:	8
Parity:	None
Stop bits:	2
Flow control:	None

5. Power up the MVP frame with the AI card installed.
6. When the AI card boots up, the following information will be printed on the terminal screen:

```
EVERTZ MCF5272 MONITOR 1.0 BUILD 22 (66 MHZ)
COPYRIGHT 1997, 1998, 1999, 2000, 2001, 2002 EVERTZ MICROSYSTEMS LTD.
28F160C3B FLASH DETECTED
PROD=3000AI
MCF5272 COLD BOOT> /      (type "CTRL-X")
MCF5272 COLD BOOT> upgrade (type "upgrade")
ARE YOU SURE YOU WANT TO UPLOAD FLASH? [Y/N] Y

UPLOAD FILE NOW, CONTROL-X TO CANCEL
□□□□□ (using the transfer/send file function, send the app.bin)
UPLOAD OKAY
BOOT>
```

7. Type CTRL-X at the first prompt, as is depicted above. This will put the AI card in the upload flash mode.



Note: If the cold-boot prompt times out, the AI card will have to be re-booted.

8. Type "upgrade" at the prompt (see above for an example).
9. When the confirmation message appears, asking if you wish to upload the flash, type "Y".

10. To upload the AI with the new application code, use the *send file* function in the terminal software, if prompted use the Xmodem for transfer.

The download can take up to 5 minutes to complete, a message will indicate that the upload is "OKAY".

When the download is complete:

1. Power down the MVP frame.
2. Remove the AI card from the frame.
3. Disconnect the upgrade serial cable.
4. Place a jumper across pins 1 and 2 on J49 ("Run mode").
5. Insert the AI card back into the MVP frame.
6. Power up the MVP frame.

The application code upgrade is now complete.

This page left intentionally blank

7. MVP™ SOFTWARE

7.1. PC MINIMUM REQUIREMENTS

- Windows 2000 PRO/Server/Windows XP PRO
- P4 2.6GHz or higher
- 512MB RAM
- 80GB HDD
- 10/100 Ethernet Nic
- From XGA to UXGA screen resolution supported
- Windows 2000 operating system
- CD-ROM player

7.2. INSTALLING SOFTWARE

1. Contact Evertz service for an update on the latest software. MVP software is only available through a private FTP site.
2. After obtaining the latest software from Evertz, run the software installer by double-clicking on the setup .exe

e.g.: mvp-setup-2.5.2.exe

3. Follow the installer's instructions.



Note: You *must* install the Maestro software and the System Manager. The System Configuration Tool is not required for the PC-based server install because this is built into the System Manager Utility.

4. After completing the install, you will have two icons on your desktop: MVP Maestro and MVP System Manager (See Figure 7-1).



Figure 7-1: System Manager and Maestro Desktop Icons

7.3. CONFIGURING A SYSTEM

The MVP System Manager utility software is used for both configuring a PC-based MVP server, and for controlling it. To set up a new system and launch the server, follow the instructions below.

1. Double-click the MVP System Manager icon on the desktop.
2. Under the System menu select, "Add System". This will launch the system configuration wizard.
3. Follow the steps in the wizard to define the MVP system that the server will be controlling.

The wizard will guide you through the following steps:

1. Provide a name for the system.
2. Select if **SNMP**, **GPI**, or **VGPI** preset loading will be used.
3. Adjust the system properties. (Ensure you carefully read the description for each property).
4. Define all of the input and output components in the system, packet routing hardware, and desktop control panels.



Note: Remember to add an IP address for each of the components.

5. Define the PLINK interconnect for the system. The setup can be visualized using the visualize links button.
4. After set-up is complete, the system should appear on the main page of the System Manager.

If changes need to be made to the configuration of the system, double-click on the system in the main page, or highlight the system and press the **modify system** button.

5. Before proceeding, the PC MVP server must be unlocked.

To unlock the server, click on the **Server LOCKED** button. Enter the server key provided as shown in Figure 7-2, with dashes "-". After entering the key, the lock symbol will change and the server will be "UNLOCKED".



Figure 7-2: Unlocking the Server

6. To start the system, click on the **Start System (GO)** button.

The status window (lower pane) of the software will report the connection status of the server to the MVP hardware. If there is a problem connecting to any of the hardware, an error message will be displayed here. Use the status tab to view the hardware components' network connection status to the MVP server. See Figure 7-3.

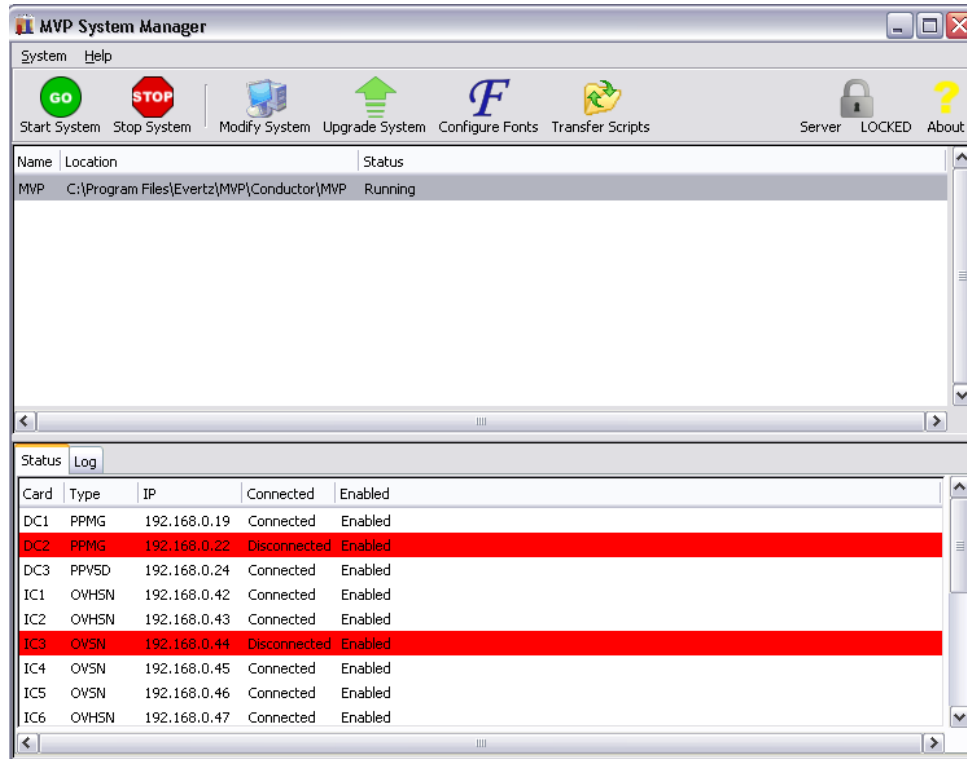

Figure 7-3: System Connection Status Window

- To stop a server, click the **Stop System** (STOP) button.
- To exit the System Manager, you must navigate to the **System** menu and then select **Quit**.



Note: If you use the windows “X” button, the program will only *minimize* to the tool tray, not exit.

7.4. ENABLING THE MVP EMBEDDED SERVER

- Use the supplied ribbon cable to connect to Jumper J13 on the card edge of the output display card.

2. Set the Com Port settings for HyperTerminal to:

Baud	115200 bps
Parity	no
Data bits	8
Stop bits	2
Flow Control	None

3. Using HyperTerminal, select **(2) On board Server Configuration**.

```
-----  
Main Menu  
(3000PPV 2.0.0rc40)  
-----  
-  
(1) Network Configuration  
(2) Onboard Server Configuration  
(3) Utilities  
(4) Under Monitor Display Setup  
(5) Auxiliary Serial Port Setup  
(6) Hardware Test Menu  
(7) Engineering/Debug  
  
(X) Exit
```

Figure 7-4: Main Menu

4. Select **(2) Enable Server**. Then select "s" to save and exit the menu.

```

-----
-----
Onboard Server Configuration
(3000PPV 2.5.1)
-----
-----
Onboard Server: Disabled
Onboard GPID: Disabled
Onboard VGPIID: Disabled
Onboard DCPd: Disabled
-----
(1) Display connection status
(2) Enable server
(3) Enable gpid
(4) Enable vgpId
(5) Enable dcpd

(S) Save and Exit
(X) Exit
>

```

Figure 7-5: Onboard Server Configuration Menu



CAUTION: Please note that *only one display card* should run the server in the system.

If two display cards exist, only enable the first display card in the system; don't enable the server on the second card.

5. Reboot the frame.
6. Verify that all the input and output cards in the system are connected to the server.
7. Using HyperTerminal select **(1) Display Connection Status** from the Onboard Server Configuration menu.

You should see messages similar to what is shown in Figure 7-6. All of the cards that are configured in the system should be displayed, along with their IP addresses. Their status should be listed as CONNECTED.

Name	IP	Status
DC1	192.168.9.17	CONNECTED
IC1	192.168.9.11	CONNECTED
IC2	192.168.9.13	CONNECTED
IC3	192.168.9.14	CONNECTED
IC4	192.168.9.16	CONNECTED

Figure 7-6: Connection Status

You can now start Maestro, connect to system, and then use the system normally.

7.5. CONFIGURING AN EMBEDDED SERVER MVP

The MVP System Configuration Tool software is used for configuring the embedded MVP server. To setup a new system, follow the instructions below.

1. Double-click the MVP System Configuration Tool icon on your desktop.
2. Enter the display card's IP address in the **Onboard Server** field.

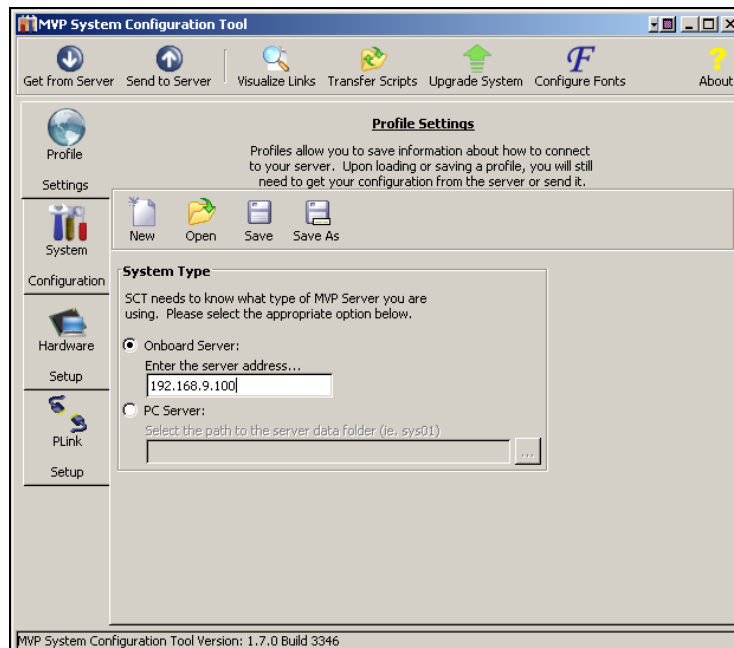

Figure 7-7: Entering the Display Card's IP Address

3. Click the **System Configuration** tab.

4. Read the description for each of the system properties carefully, then select the properties you would like to enable for the server.

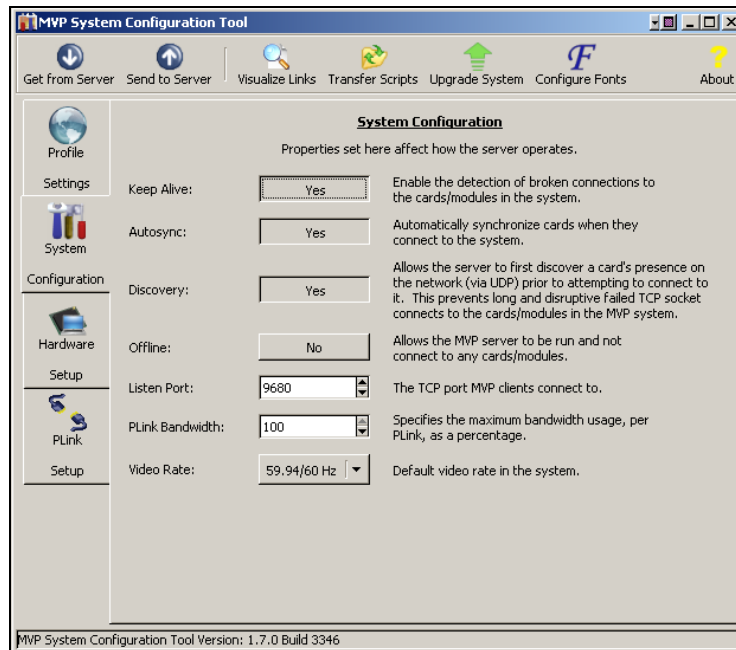

Figure 7-8: System Configuration Screen

5. Click the **Hardware Setup** tab.
6. List all of the hardware components (input cards, output cards, and desktop control panels) in the MVP system by entering the component's name, choosing the component's type from the drop-down list, and entering the component's IP address.

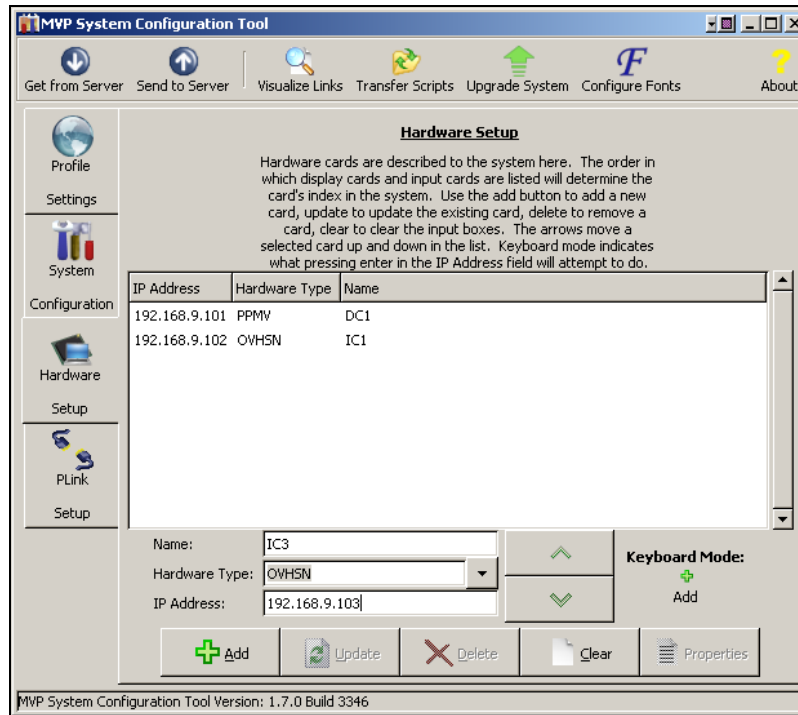

Figure 7-9: Entering Hardware Components

7. Click the PLINK Setup tab.
8. List all of the PLINK interconnects in the system by selecting the card and output from the list, and then selecting the destination card and input port from the drop-down box at the bottom of the window.

Use the Visualize Links button to review the hardware and PLINK assignments.

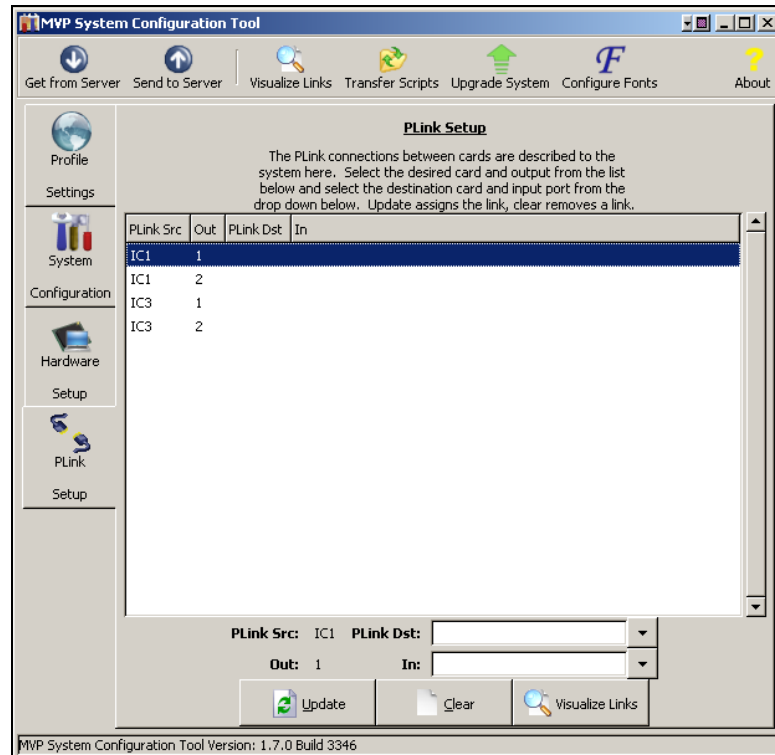

Figure 7-10: PLINK Setup Screen

9. After completing setup, send the configuration to the MVP server by clicking the **Send to Server** button.

7.6. ADDING A SYSTEM TO MAESTRO SOFTWARE

1. Double click the “MVP Maestro” icon on your desktop.



Figure 7-11: MVP Maestro Icon

2. Once the software has loaded, a login dialog box will appear. You must enter a username and password in order to gain access to the program.
3. The default username is “admin”, with no password. Type “admin” in the **User Name** field and press <ENTER>.
4. If you are starting Maestro for the first time, there will not be any MVP systems present in the opening screen, an Add System form (as shown in Figure 7-12) will open up automatically after log-in.

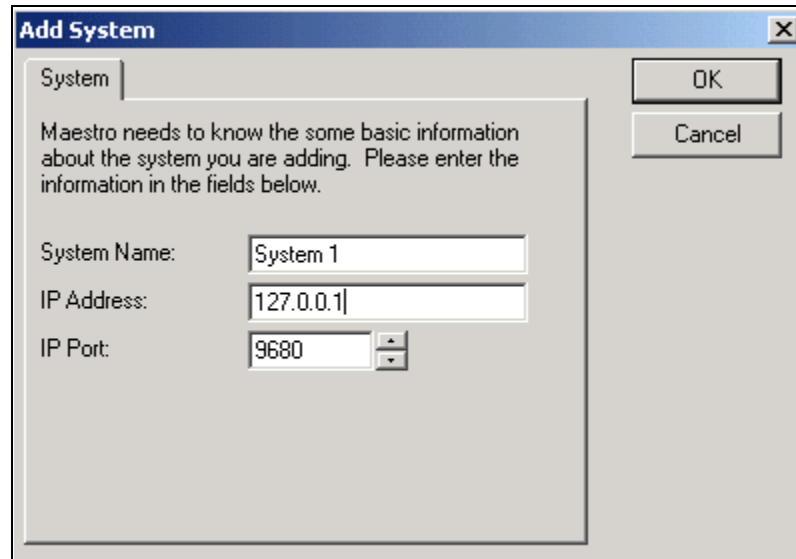

The 'Add System' dialog box contains the following fields and controls:

- System Name:** Text input field containing 'System 1'.
- IP Address:** Text input field containing '127.0.0.1'.
- IP Port:** Spin box containing '9680'.
- Buttons:** 'OK' and 'Cancel' buttons on the right side.
- Text:** 'Maestro needs to know the some basic information about the system you are adding. Please enter the information in the fields below.'

Figure 7-12: Add System Form

5. Enter a name for the system in the **System Name** field (e.g.: System 1).
6. In the **IP Address** field, enter the IP address of the PC that the server (conductor) is running on.

Note: If the server is running on the same PC as the Maestro client, enter 127.0.0.1. This is a loop back address (i.e.: the server will query the PC for an IP address).

7. Select the IP port number that was chosen during the System Configuration (9680 is default) in the **IP Port** field.

Maestro will contact the server and read back all of the configuration files to determine the type of system it will control. You will now have a System Icon on the System Manager page similar to the one shown in Figure 7-13.

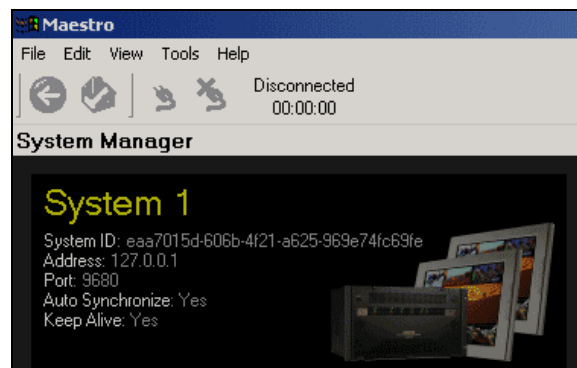

Figure 7-13: System Icon

7.7. CONNECTING TO THE SYSTEM

1. Double-click on the System Icon. This will take you to the Display Manager window. You should see a display icon for every output of the display card.

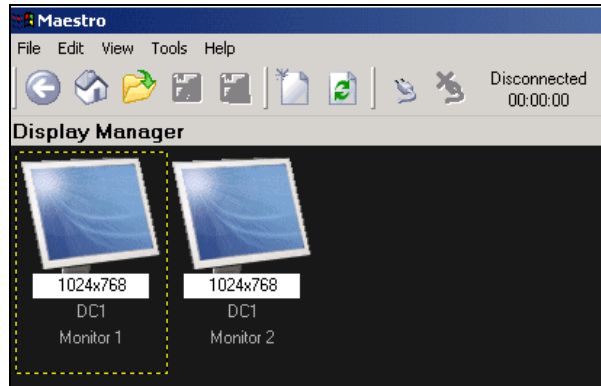

Figure 7-14: Display Icons

2. Press the **Connect** button at the top of the screen.

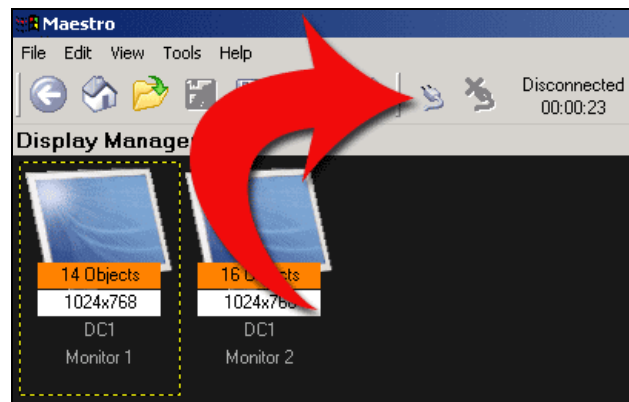
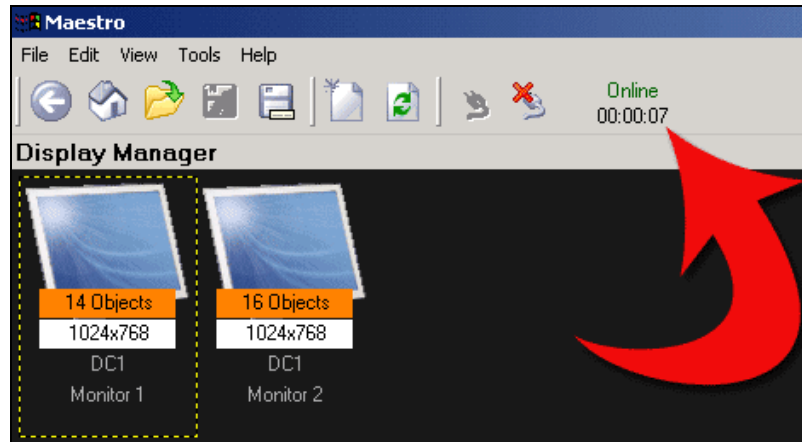

Figure 7-15: Connect Button

3. At this time you should see that the system is **Online** and a counter should start counting up.



4. To clear the system for the first time, perform a System reset by selecting **Tools > Reset System**.
5. Double-click on one of the Display Icons to enter the **Design Canvas Overview** screen for that display output.
6. Double-check the operation of the system by placing clocks and input windows on the display and verifying that they appear correctly.

For more information on using the Maestro software, refer to the Maestro User Manual.

7.8. MVP UPGRADE

The MVP software is only available through a private FTP site; therefore you must contact Evertz customer service for software updates.

To perform the upgrade:

1. After obtaining the latest software from Evertz, run the software installer by double-clicking on the setup .exe file

e.g.: mvp-setup-2.5.2.exe

2. Follow the instructions provided by the installer.



Note: You *must* install the Maestro software and the System Configuration Tool.

3. After completing the install you will have two icons on your desktop: MVP Maestro and MVP System Configuration Tool.



Figure 7-16: System Configuration and Maestro Icons

7.9. CONFIGURING THE ALARMS

7.9.1. Configuration of Alarms in Maestro

1. Launch the Maestro application and ensure that a system is created in Maestro for the MVP. Please note that the following screens refer to the VIP, however the MVP and VIP are configured in the same way and therefore the user can follow the same instructions in order to configure the MVP.



Figure 7-17: Maestro System Manager

2. To access the *Display Manager*, double click on the desired system from the *System Manager* list.

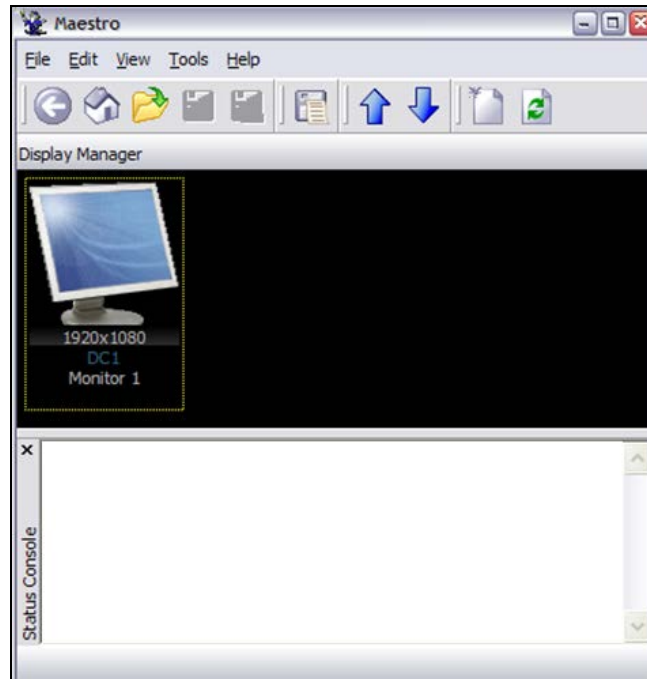

Figure 7-18: Maestro Display Manager

3. To enter the *Design Canvas Overview*, double click the display that the alarm will appear on.

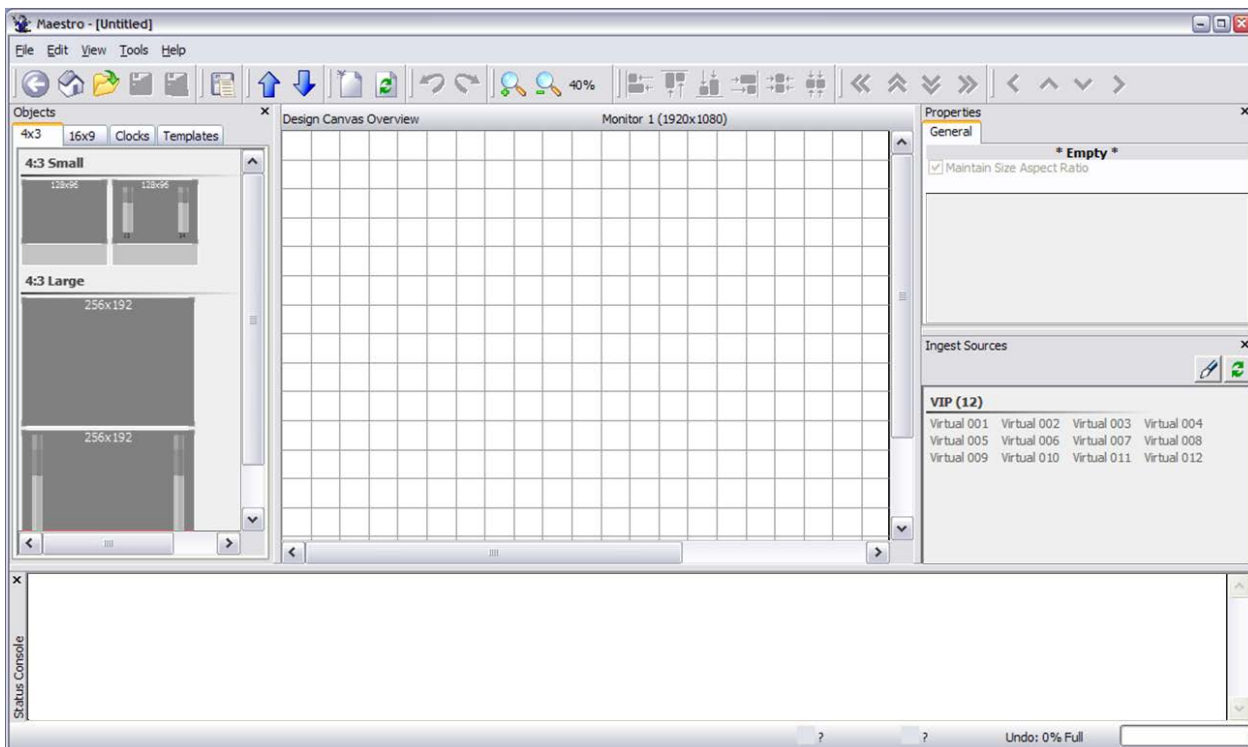

Figure 7-19: 4x3 Display

4. To open the alarm, drag and drop a window onto the design canvas. Once the window is displayed, assign the appropriate source to be monitored.

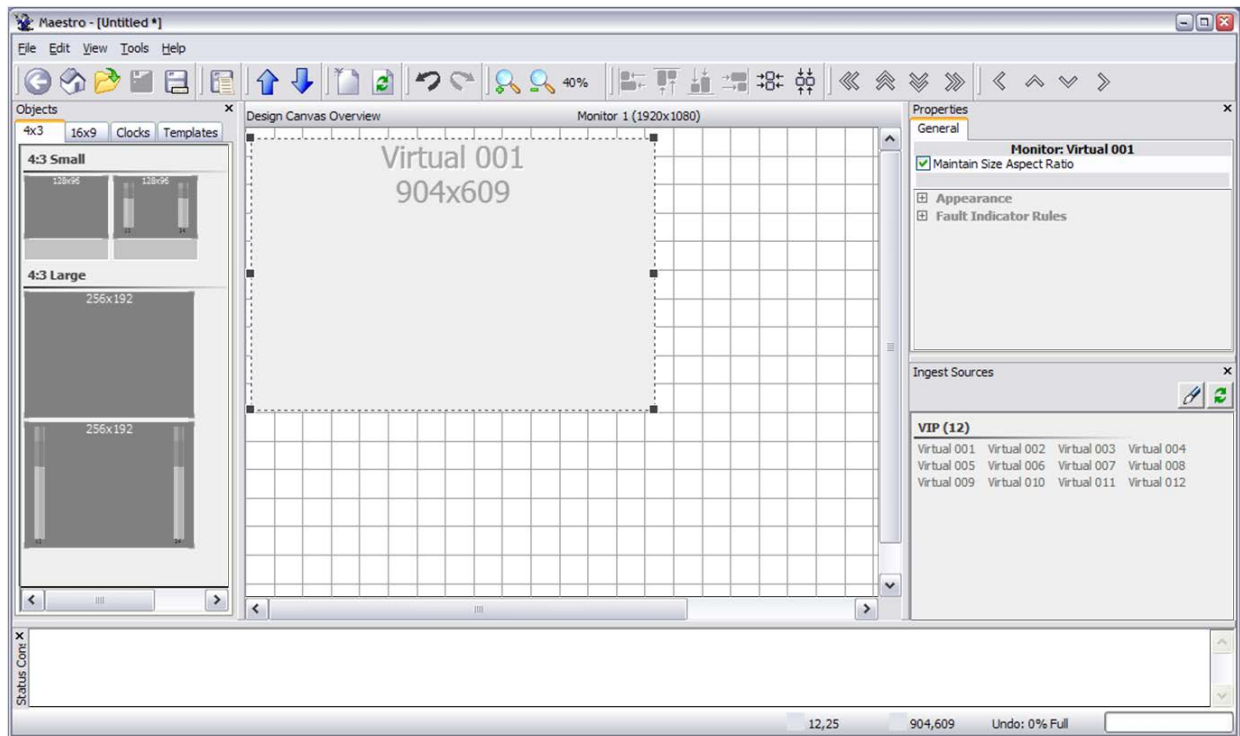

Figure 7-20: Object on Design Canvas

5. To enter the interior design, double click on the video window.
6. Select the *Status* tab and drag a fault label onto the video window.
7. Double click on the fault label to edit the properties of the label.

The text can be renamed to more accurately reflect the error/alarm. For example, if the fault is triggered on a loss of video, the text can be changed to “Loss of Video”.

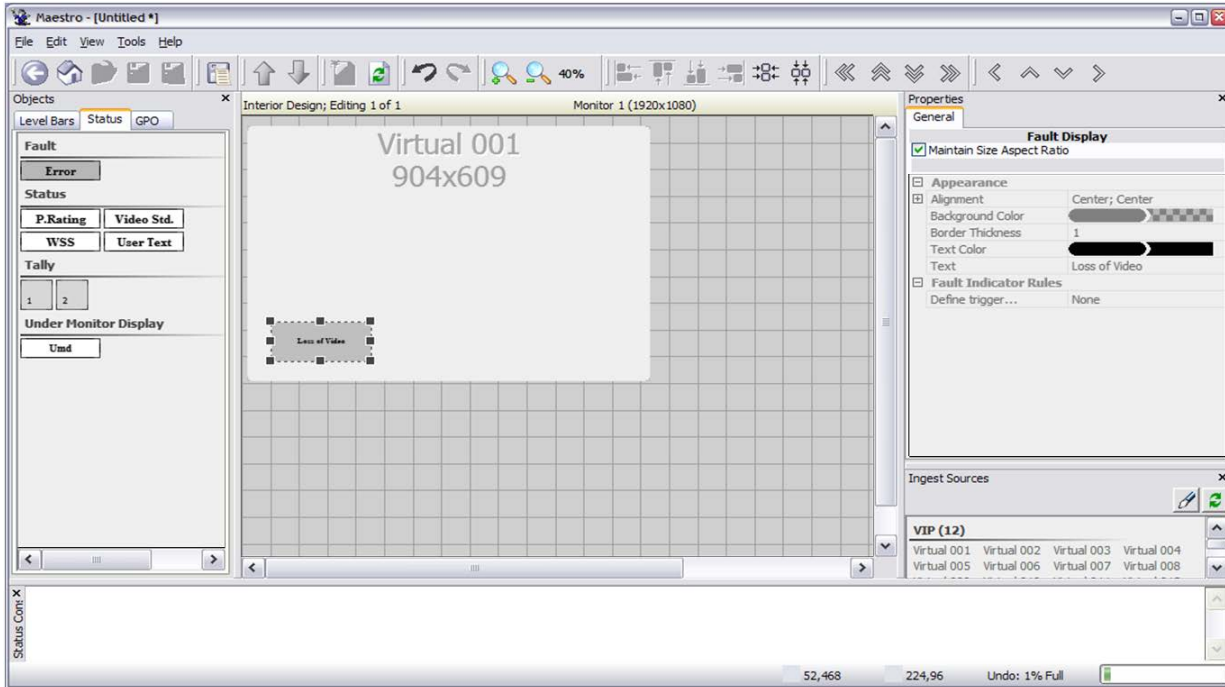

Figure 7-21: Maestro Fault Display

8. From the right hand window pane navigate to the *Fault Display* section and expand the *Fault Indicator Rules*. The *Fault Indicator Rules* enables the user to define the trigger of the error/alarm. To set the trigger, place a check mark beside the appropriate trigger option in the *Define Trigger* window, such as *Loss of Video* as shown in Figure 7-22. Once the appropriate trigger is defined, select OK.

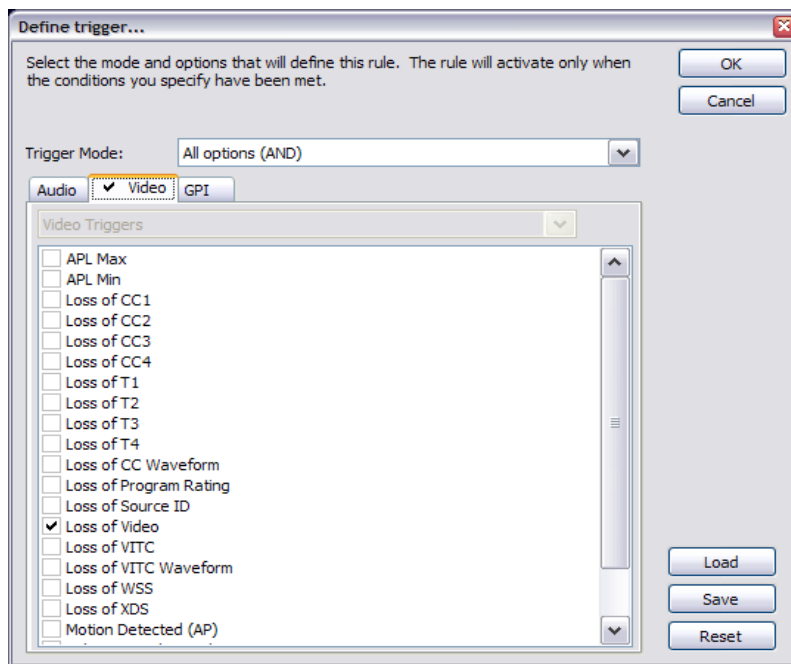

Figure 7-22: Defining Trigger for Video

9. The setup of a preset with alarm monitoring is now complete. VLPro - C can be used to adjust the parameters of the error/alarm (see section 7.9.2).

7.9.2. Adjusting Parameters for Alarms in VLPro – C

1. To adjust the parameters for the alarms, launch the VLPro – C (Configuration Only) software and ensure that the card that you are configuring appears in the Navigation Tree. Also, ensure there is Ethernet communication with the card and the PC is running VLPro.

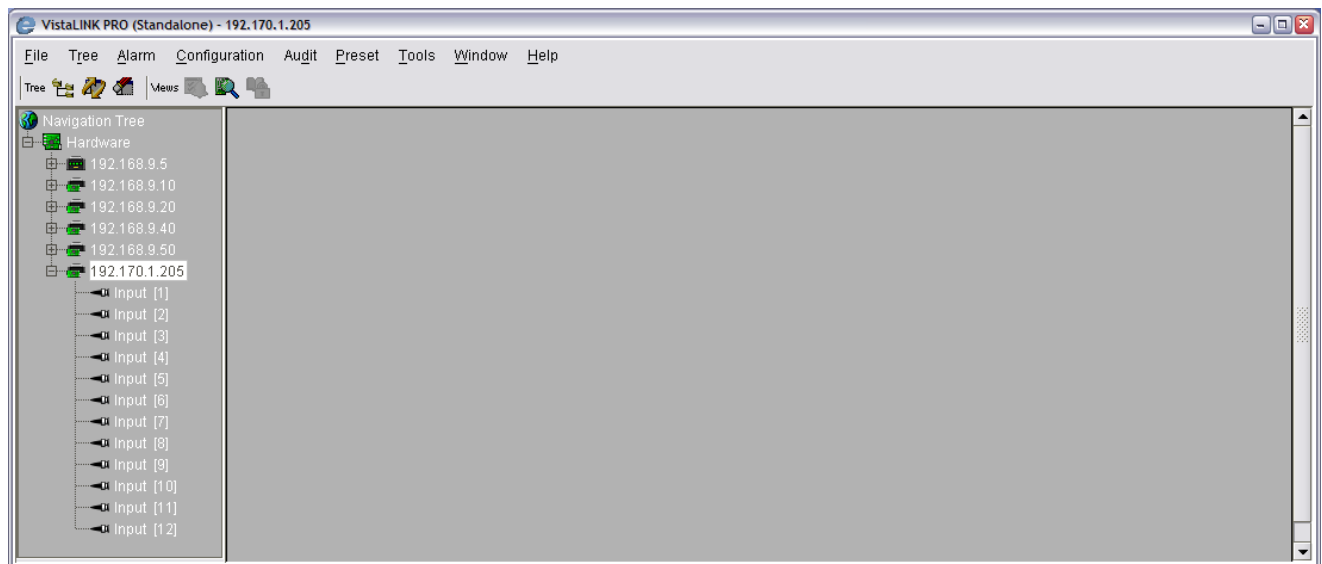

Figure 7-23: VistaLINK® Navigation Tree

2. Right click on the input that is to be configured (for example, Input 1 in Figure 7-23) and select *View Configuration* from the drop down menu. Now VLPro will communicate to the card and retrieve the current status of the parameters.

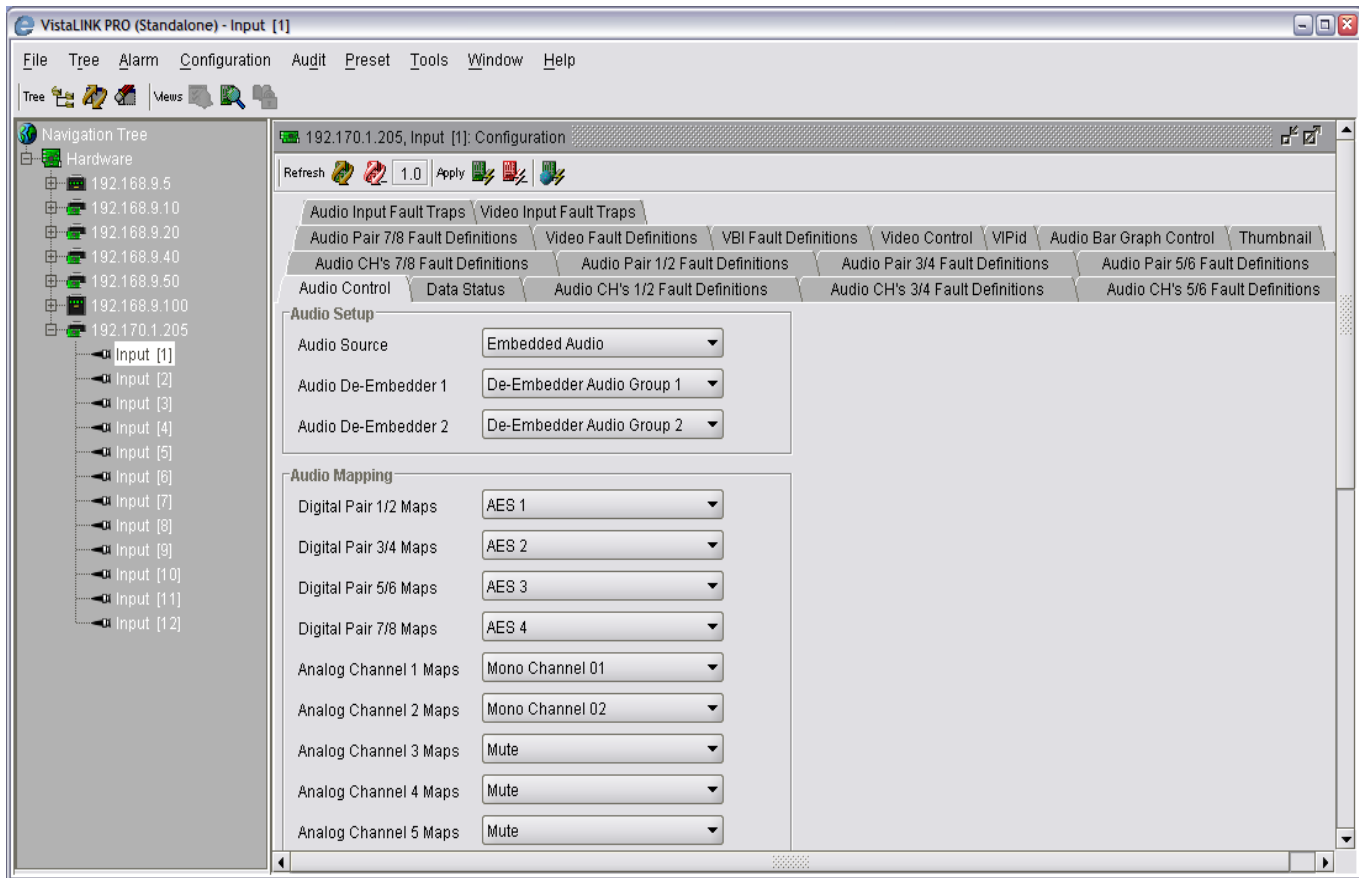

Figure 7-24: Audio Control Tab

3. The user will be required to set the parameters for the amount of frames of video loss before the alarm will trigger. To configure this setting, select the appropriate input (for example, Input 1 in the Figure 7-25) and then select the *Video Fault Definitions* tab. By default this parameter is set to 0 frames, however this parameter has a value range of 0 to 900 frames. The *Video Loss Reset Duration* is the amount of time after the fault has corrected that the label will be visible. Once all parameters have been set, ensure to apply the changes in order to send the new parameters to the card.

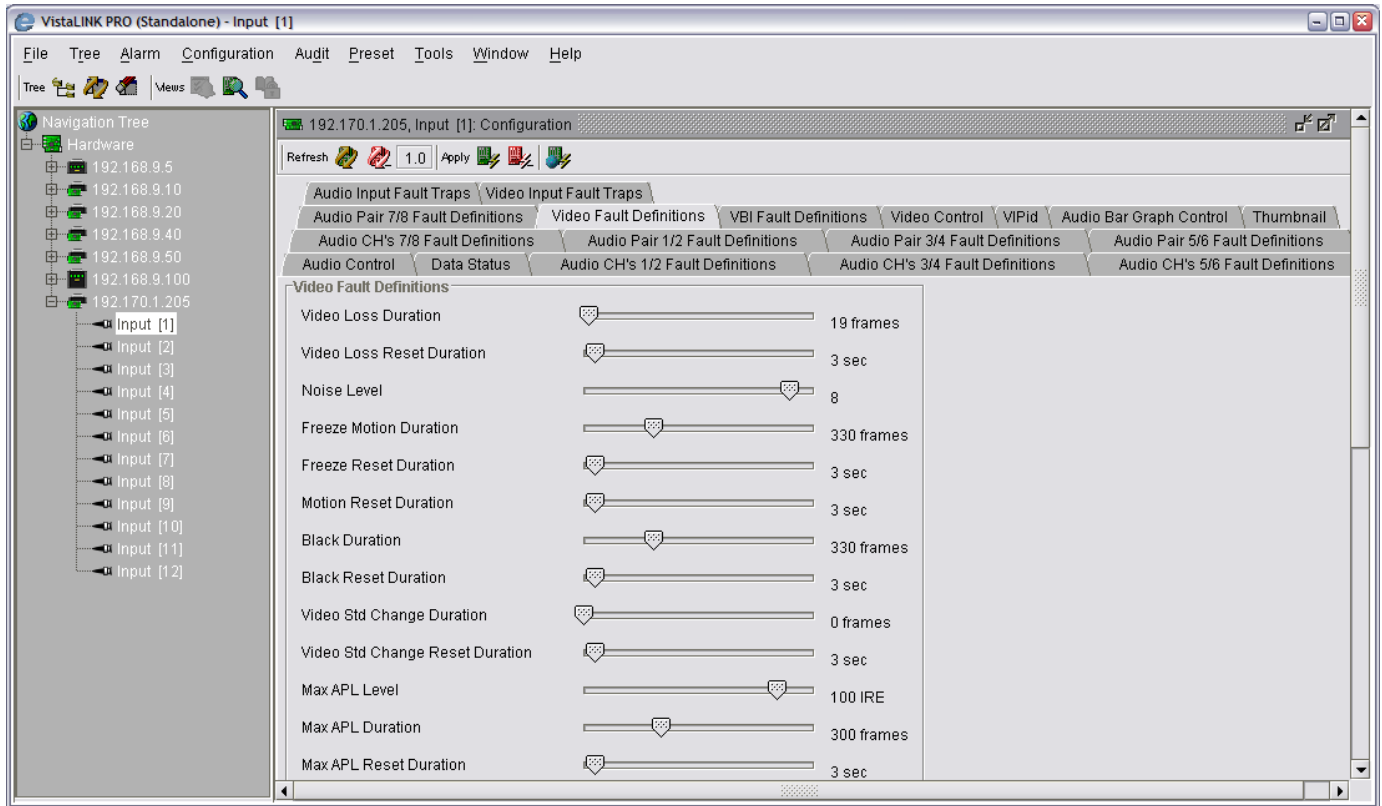
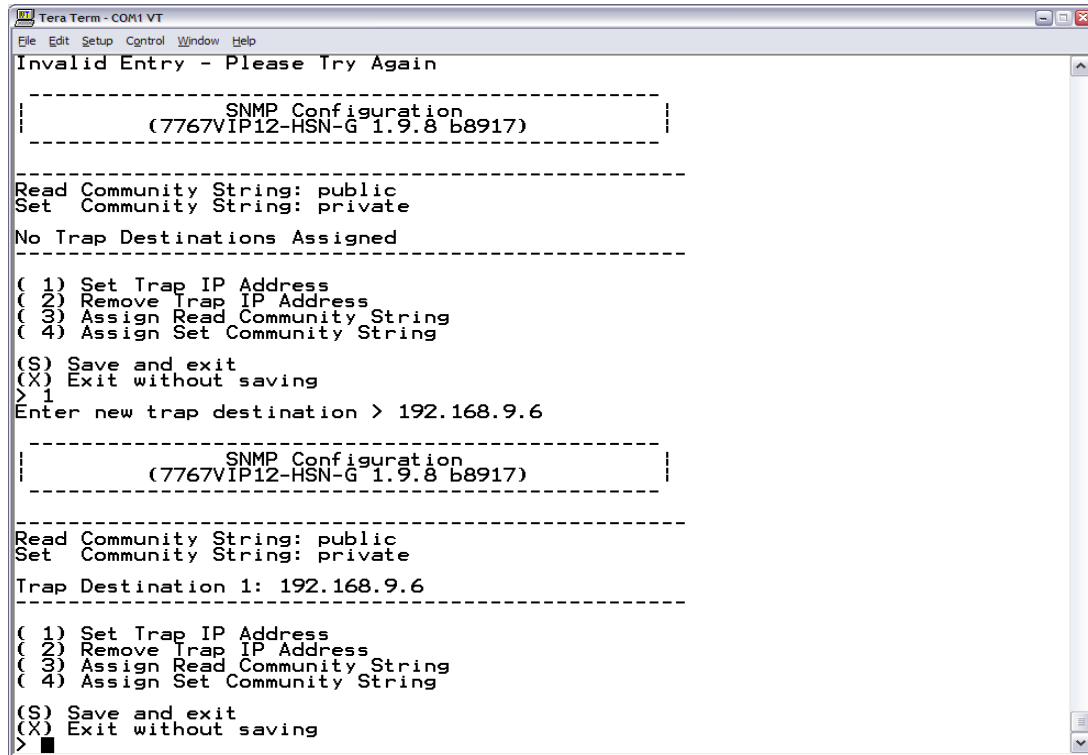

Figure 7-25: Video Fault Definitions Tab

4. The faults/alarms have now been configured. If there is a need to log or trap the alarms, the user will require the VLPro Server and Client software.

7.9.3. Configuring the Traps

1. To configure traps, launch the VLPro Server and Client.
2. Connect the serial upgrade cable to the card edge.
3. Select the *SNMP Configuration* option from the menu.
4. Select option 1 from the *SNMP Configuration* menu and enter the IP Address of the server that will be collecting/logging the traps. Please note that the user can set more than one trap destination.



```
Tera Term - COM1 VT
File Edit Setup Control Window Help
Invalid Entry - Please Try Again

-----
                SNMP Configuration
            (7767VIP12-HSN-G 1.9.8 b8917)
-----

Read Community String: public
Set Community String: private

No Trap Destinations Assigned
-----

( 1) Set Trap IP Address
( 2) Remove Trap IP Address
( 3) Assign Read Community String
( 4) Assign Set Community String

(S) Save and exit
(X) Exit without saving
> 1
Enter new trap destination > 192.168.9.6

-----
                SNMP Configuration
            (7767VIP12-HSN-G 1.9.8 b8917)
-----

Read Community String: public
Set Community String: private

Trap Destination 1: 192.168.9.6
-----

( 1) Set Trap IP Address
( 2) Remove Trap IP Address
( 3) Assign Read Community String
( 4) Assign Set Community String

(S) Save and exit
(X) Exit without saving
> █
```

Figure 7-26: SNMP Configuration

- Once all the trap destinations have been set, select the (S) *Save and exit* option from the *SNMP Configuration* menu. The card must be rebooted for the new settings to take effect.
- Select the card that the logging of traps will occur on. To view the selected card configuration, right click and select *View Configuration*. Select the *Audio Input Fault Traps* tab and the *Video Input Fault Traps* to set the type of traps that VLPro will log. To set the desired traps for logging, check or uncheck the appropriate item in the list of traps. Once complete, select the *Apply* button for the changes to take effect.
- The fault parameters can also be set with the VLPro Client. Once a fault is triggered it will be logged in the VLPro Client.

8. CONFIGURING THE 3000DCP DESKTOP CONTROL PANEL

Please note that this section assumes that the MVP Server has already been installed and configured. If you have not already done so, please install and configure the MVP Software using the instructions in section 7.

8.1. FOR SYSTEMS USING ONBOARD SERVER

8.1.1. Creating the System and Setting up the Hardware

1. Launch the **System Configuration Tool (SCT)**.
2. Select the **Profile Settings** tab.
3. Select "Onboard Server" as the **System Type**, and enter output card's IP address in the text field marked "Enter the server address..."
4. Press the **Get from Server** button at the top of the SCT to retrieve the system configuration for this system.
5. Select the **Hardware Setup** tab.
6. Add a DCP to the hardware list by filling in the name (e.g.: DCP1), type (DCP), and IP address fields. See Figure 8-1.

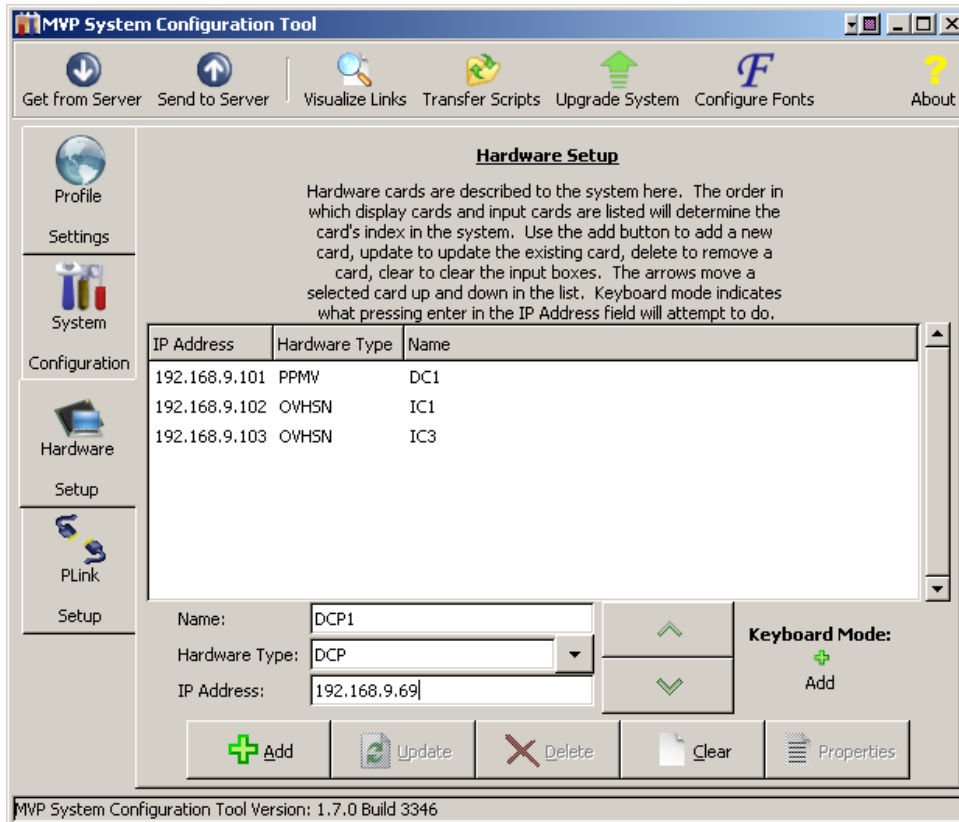

Figure 8-1: Adding DCP to Hardware List

7. Press the **Send to Server** button at the top of the SCT window to send the new configuration to the server.
8. Select the **Transfer Scripts** button located at the top of the SCT.
9. In the **Transfer Scripts** window that appears:
 - For **Local File**, browse to and select:

```
C:\ProgramFiles\Evertz\mvp\conductor\sys01\samples\dcbasic.vssl
```
 - For **Server File** select **DCP Config** from the dropdown menu.
10. Press the **Send to Server** button to send the DCP configuration file to the server, and then close the **Transfer Scripts** window.

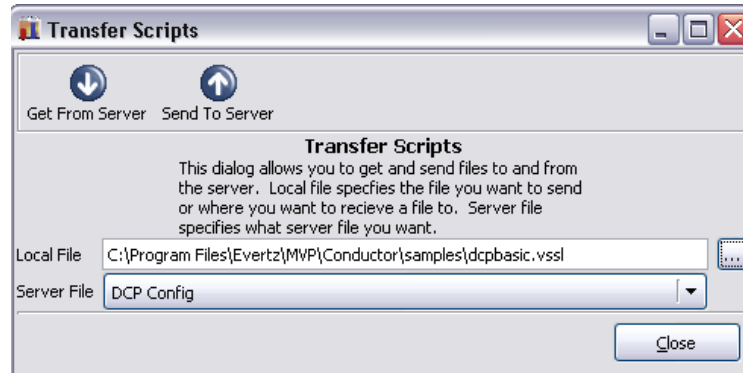

Figure 8-2: Transfer Scripts Window

8.1.2. Enabling the DCP Server

1. Connect a serial cable to the serial port of the output display card running the server. Refer to section 3.20 for instructions on how to perform this task.

```

-----
|                               |
|           Onboard Server Configuration           |
|           (3000PPV 2.6.0)                       |
|                               |
-----
Onboard Server: Enabled
Onboard GPID: Disabled
Onboard VGPIID: Disabled
Onboard DCPD: Disabled
-----
(1) Display connection status
(2) Enable server
(3) Enable gpid
(4) Enable vgpid
(5) Enable dcpd

(S) Save and Exit
(X) Exit
> > 1

```

Figure 8-3: Onboard Server Configuration Menu

2. Select **(5) Enable dcpd** and then select **YES**.
3. Select **(S) Save and Exit**.
4. Reboot the display card.

8.2. FOR SYSTEMS USING PC SERVER

1. Launch the **MVP System Manager** and navigate to the **System** menu and then select **Modify System**.
2. Select the **Hardware Setup** tab.
3. Add a DCP to the Hardware list by filling out the name, type, and IP address fields. See Figure 8-4 below.
4. When you have entered the information, click **Add**, and then **OK**.
5. Select **YES** to restart the server.

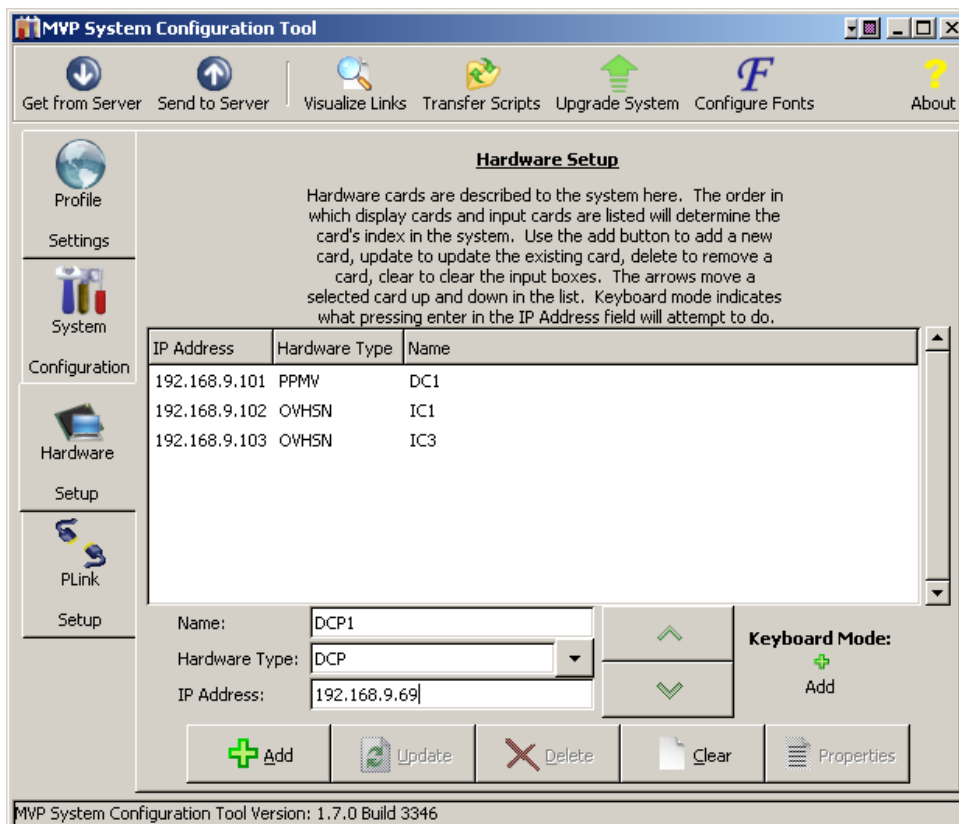

Figure 8-4: Adding the DCP to the Hardware List

6. Click the **Transfer Scripts** button in the MVP System Manager.

A **Transfer Scripts** window will appear.

For **Local File**, browse to and select

C:\Program Files\Evertz\mvp\conductor\sys01\samples\dcpbasic.vssl

For **Server File**, select **DCP Config** from the dropdown menu (see Figure 8-5 below)

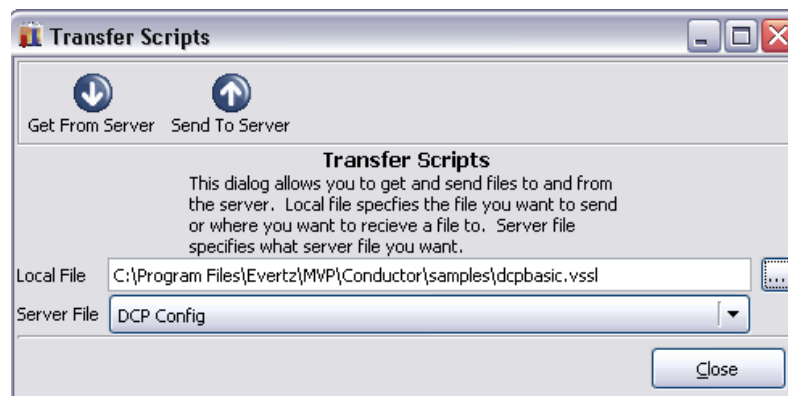

Figure 8-5: Transfer Scripts Window

7. Press the **Send to Server** button to send the DCP configuration file to the server.
8. Close the **Transfer Scripts** window.
9. Stop and restart the server.

8.3. FOR PC AND ONBOARD SERVER – DCP SETUP

1. Press the Select and Setup buttons on the DCP at the same time to enter the setup menu.
2. Ensure that the DCP has the correct IP address as entered in the Hardware Setup Table.
3. Verify all network settings. Use the arrow buttons and rotary knob to enter network information. Also ensure that the DCP is connected to the same network as the MVP, and can be pinged from the PC running the Maestro application.

It may take a few seconds in order for the DCP to connect.

When it does, the dot-matrix display will go from displaying “No Clients Connected” to “Evertz 3000DCP DCPd@ xxx.xxx.xxx.xxx”.

DCP presets are saved using the format “dnn-pnn”, where nn is the display number and preset button number.

Use the Maestro software to save presets as a script (**File > Save as script**) using the described format. Maestro will automatically place the preset for the DCP in the correct location.

Example:

d01-p01, assigns the preset to display 1 preset button 1
d01-p12, assigns the preset to display 1 preset button “shift” 2 (12)
d04-p08, assigns the preset to display 4 preset button 8

8.4. UPGRADING THE 3000DCP

The following are instructions on how to perform a firmware upgrade on the 3000DCP desktop control panel. Please note that these are secondary methods to performing this upgrade, as it is normally completed in **System Configuration Tool (Hardware Settings > Update)**.

To use the serial method (baud rate = 115200, 8 data bits, N parity, 2 stop):

1. Connect a serial port to the DB-9 serial connector on the back of the DCP.
2. Hold down the **Undo** button and the **Setup** button while powering on the DCP.
3. Using the serial terminal, hit **CTRL-X** at the prompt to put unit in upgrade mode.
4. At the prompt type "upload".
5. Use the terminal software to send the new firmware file using X-modem.
6. After the firmware has been transferred, power cycle the unit.

To use the FTP method:

1. Open a dos window.
2. At the prompt, type "ftp xxx.xxx.xxx.xxx" where the x's represent the IP address of the DCP.
3. Hit <ENTER> for user name, and password.
4. Type "put filename.bin" at the ftp prompt, where "filename.bin" represents the released firmware for the device.
5. After the file has been transferred successfully, type "quit".
6. Power cycle the DCP.

9. SETTING UP PRESET LOADS

9.1. SETTING UP A GPI PRESET LOAD – OFFBOARD SERVER

Please note that this procedure assumes an MVP Server has already been installed and configured. If you have not already done so, please refer to section 7 for instructions on installing and configuring an MVP Server.

These instructions also assume the default install location of MVP software. If you have installed the MVP software elsewhere, please substitute your install location wherever the default location is referenced below.

Initial configuration of GPI presets requires the use of Windows Explorer and Notepad. GPI preset loads are configured through two files: actions.vssl and gpicfg.vssl

9.1.1. The gpicfg.vssl File

The gpicfg.vssl file maps actions to GPIs. These mapped actions are used to define what the gpi will do (e.g.: load a preset).

The syntax for the gpicfg.vssl file can be broken down into three parts:

Part 1: obj GPISource ("DC1")

This defines where the GPIs are connected. When running the Offboard Server, this entry must be set to the name of first output card listed in the **Hardware Setup** tab of the **Server Manager**, and only the GPIs connected to that card may be used for preset loads. For all other output cards in the system, the GPIs will operate normally.

Part 2: obj gpi(1)

This defines the GPI that will trigger the action (i.e.: the preset load).

Part 3: { action = "presetload" }

The action allows the system to link a GPI to an operation (i.e.: a preset load). The name of the action defined in the gpicfg.vssl will then be called in the actions.vssl file, the second configuration file. The actions.vssl file will define that operation.

Example of a configured gpicfg.vssl file

```
obj GPISource ("DC1") {
    obj gpi(1) { action = "presetload" }
}
```

This configuration maps GPI 1 for DC1 to an action called "preset load".

9.1.2. The actions.vssl File

The actions.vssl file maps actions to a function. These mapped actions are used to define what the action will do (e.g: load a preset).

The syntax for the actions.vssl file may be broken down into three parts:

Part 1: obj ActRunScript("presetload")

This defines the name of the action. The name is referenced by gpicfg.vssl

Part 2: script = "preset1.vssl"

This defines the name of the script file (preset) that will be triggered by the action. The script file is created in Maestro during design mode.

Part 3: display = 1

This defines the output that the preset will be loaded on. This is a logical output number.

Example DC1, 1,2,3,4, DC2, 5,6,7,8

Example of a configured actions.vssl file

```
obj ActRunScript("presetload") {
    script = "preset1.vssl"
    display = 1
}
```

This configuration maps the action "presetload" to the preset "preset1.vssl" which will be loaded on the first output of the first display card in the system.

9.1.3. How to Set Up a GPI Preset Load (Offboard Server)

Follow the instructions below to set up a preset load.

Part 1: Editing the gpicfg.vssl File

1. From a Windows 2000/XP operating system, using Windows Explorer, browse to the default install location of MVP software:

C:\Program Files\Evertz\MVP\Conductor\Samples

2. Double-click the file called gpicfg.vssl, and then select **Open With** or **Select Program From List**, depending on your operating system.

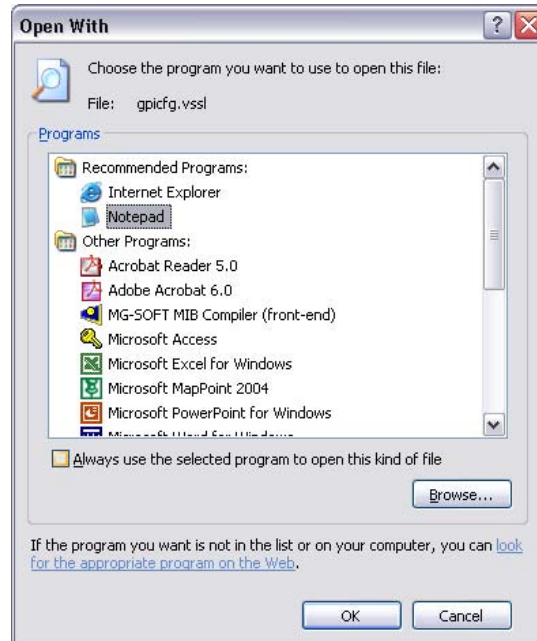

Figure 9-1: Open With Window

3. Select **Notepad**, and click the checkbox beside **Always use the selected program to open this kind of file** and then click **OK**.

Note: When using Notepad, make sure that Word Wrap is disabled. A checkmark appears next to Word Wrap if it is enabled. To disable Word Wrap, click on Word Wrap in the Format menu. This will disable Word Wrap, removing the checkmark.

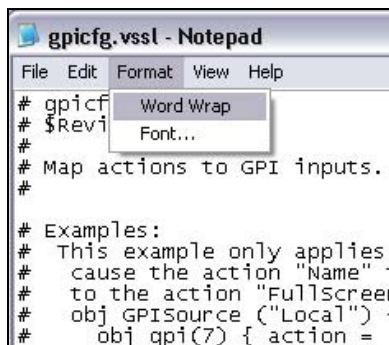

Figure 9-2: Word Wrap

4. When you are finished editing, save the file, making sure that **Save as type** is set to **All Files** from the drop-down list.

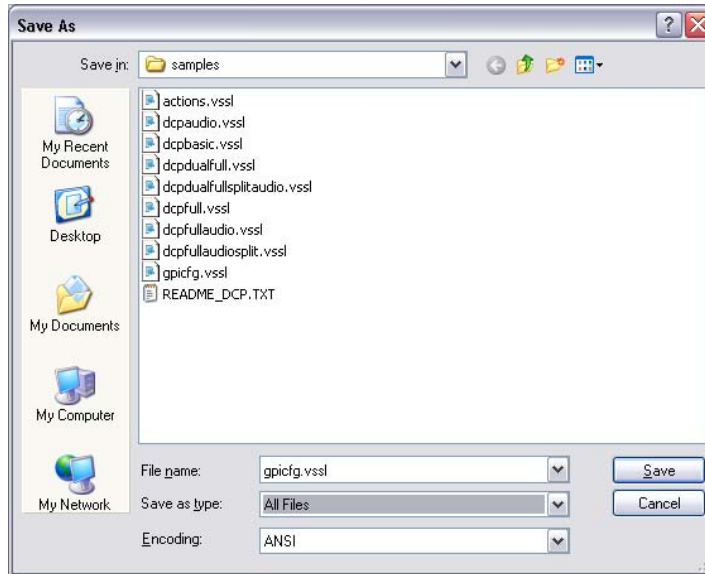

Figure 9-3: Save As

Part 2: Editing the actions.vssl File

1. From a Windows 2000/XP operating system, using Windows Explorer, browse to the default install location of MVP software:
C:\Program Files\Evertz\MVP\Conductor\Samples
2. Double-click the file called actions.vssl, and select **Open With** or **Select Program from List**, depending on your operating system.



Figure 9-4: Open With

3. Select **Notepad**, and also click the checkbox beside **Always use the selected program to open this kind of file** and then click **OK**.

Note: When using Notepad, make sure that word wrap is disabled. A checkmark appears next to Word Wrap if it is enabled. To disable Word Wrap, click on Word Wrap in the Format menu. This will disable Word Wrap, removing the checkmark.

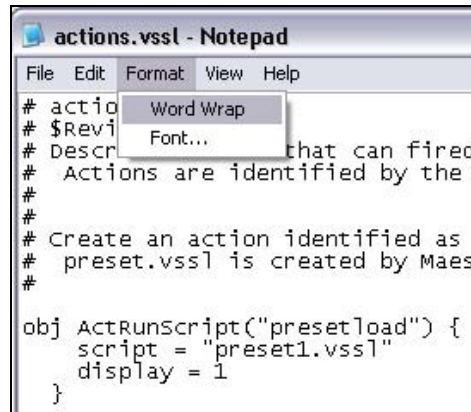

Figure 9-5: Word Wrap

4. When you are finished editing, save the file, making sure that **Save as type** is set to **All Files** from the drop-down list.

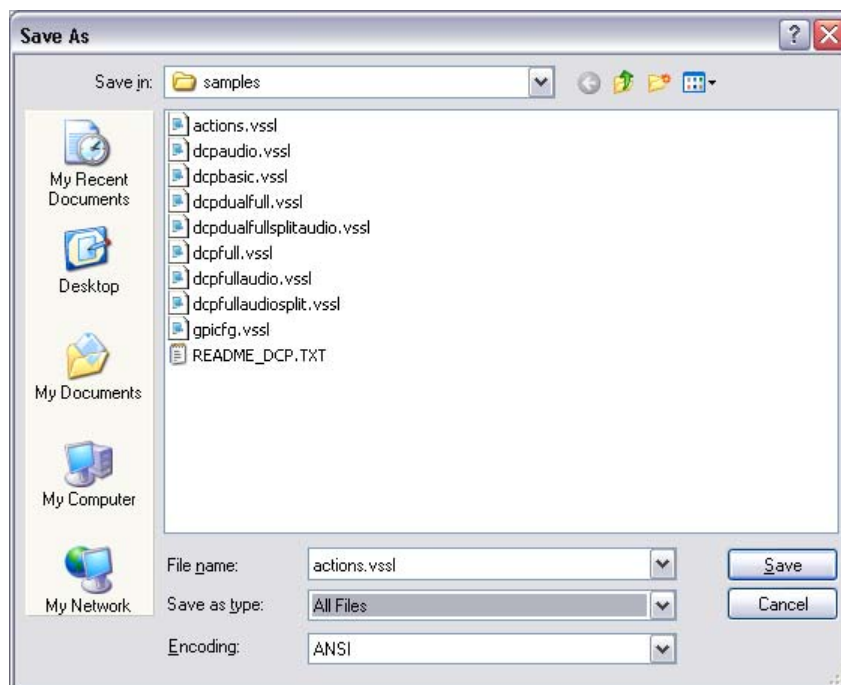

Figure 9-6: Save As

Now that gpicfg.vssl and actions.vssl have been configured and saved, they need to be sent to the server.

Part 3: Transferring the Gpicfg.vssl and Actions.vssl Files (Offboard Server)

1. Launch the **MVP System Manager**, and select the system that will be using GPI based preset loads.

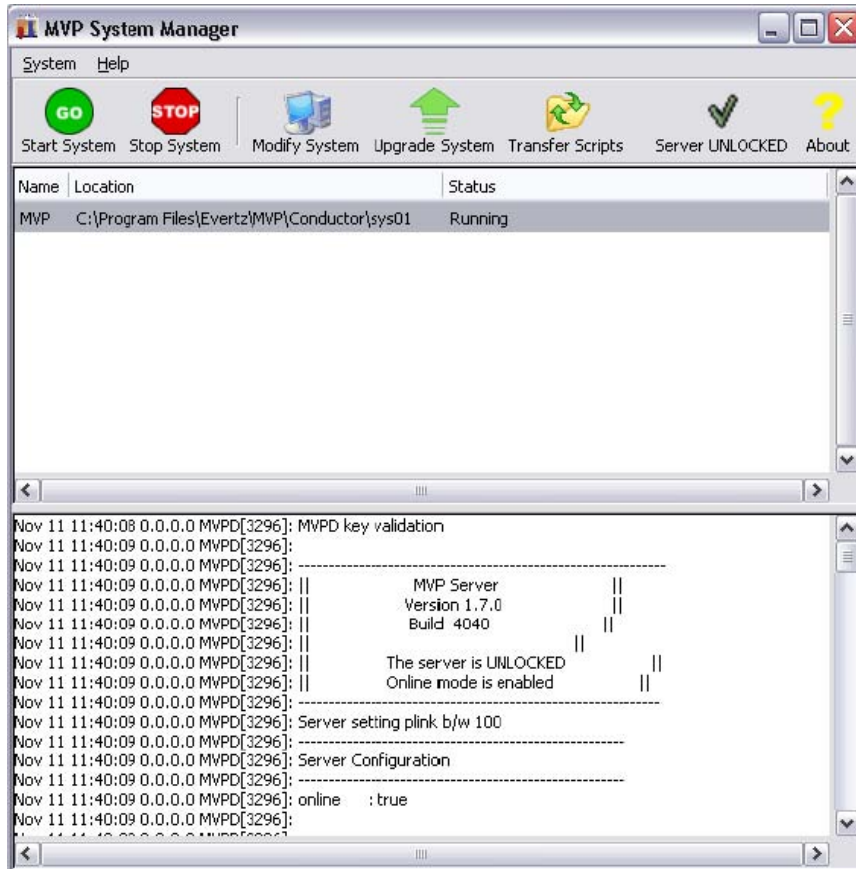



Figure 9-7: MVP System Manager

2. Click on **Transfer Scripts**, which will launch the window below.



Figure 9-8: Transfer Scripts

3. Click on the  button to open a browse window. Browse to where the **gpicfg.vssl** and **actions.vssl** files were saved.

The default location is **C:\Program Files\Evertz\MVP\Conductor\Samples**

4. Select **actions.vssl** and click open. The Transfer Scripts menu will appear again.
5. From the **Server File** drop-down box, select **Actions**.



Figure 9-9: Transfer Scripts

6. Click on **Send to Server**. The file **actions.vssl** will be sent to the server.
7. Click on the  button to open a browse window. Browse to where the **gpicfg.vssl** and **actions.vssl** files were saved.

The default location is **C:\Program Files\Evertz\MVP\Conductor\Samples**

8. Select **gpicfg.vssl** and click open. The Transfer Scripts menu will appear again.
9. From the **Server File** drop-down box, select **GPI Config**.



Figure 9-10: Transfer Scripts

10. Click on **Send to Server**. The file `gpicfg.vssl` will be sent to the server.

The last step is to enable the GPId daemon.

Part 4: Enabling GPId Daemon Using an Offboard Server

The ability to load presets on a display is controlled by a daemon called GPId that runs in the MVP Server Manager.

This daemon is **only** used to load presets on a display, **it is not required with normal GPI operation**.

1. Launch the **MVP System Manager**

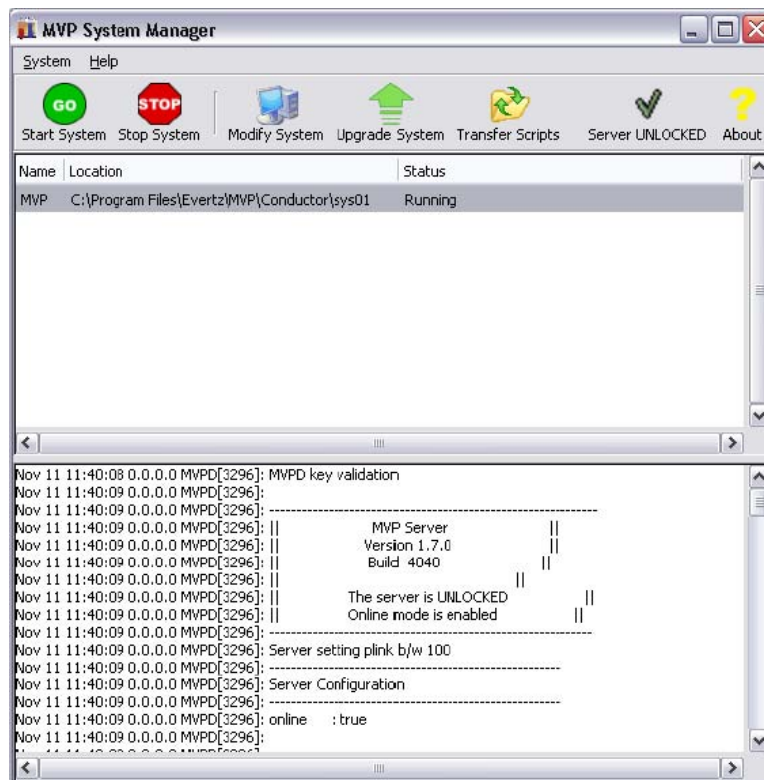

Figure 9-11: MVP System Manager

2. Click on the **Modify System** button.

3. Select the **Global Setting Tab**, and click the check box labeled **Use GPI**.

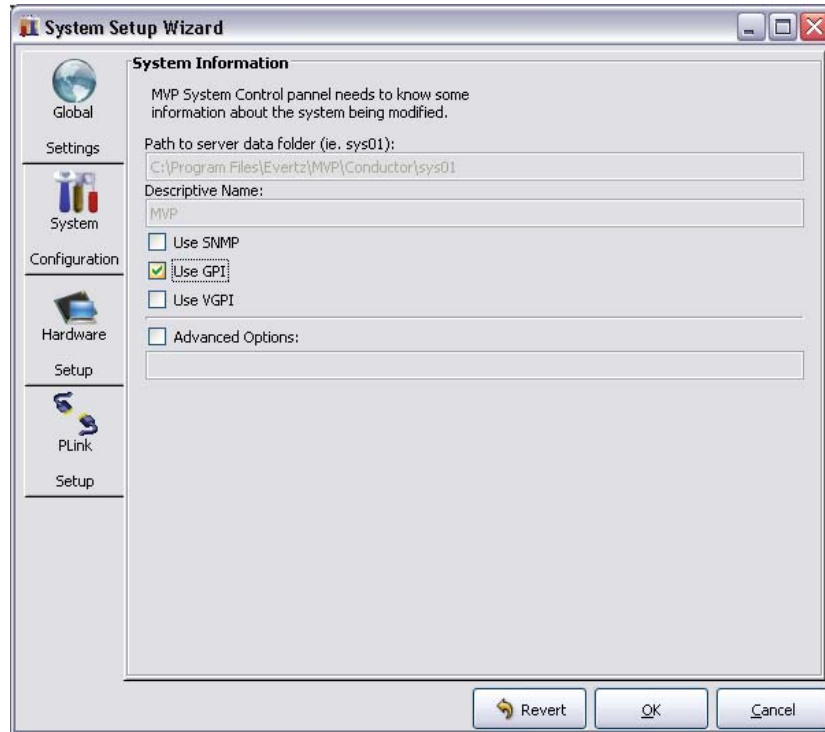
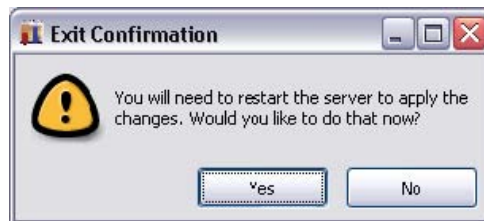

Figure 9-12: Global Settings

4. When you have made these selections, click on **OK** to save the changes.

The system will then display the following message:



6. Click **Yes** to restart the server.

When the server has restarted, GPIs can be used to load the defined presets in the **gpicfg.vssl** and **actions.vssl** files. Please refer to the Maestro manual for instructions on how to create the presets.

9.2. SETTING UP A GPI PRESET LOAD - ONBOARD SERVER

Please note that this procedure assumes an MVP Server has already been installed and configured. If you have not already done so, please refer to PLACEHOLDER for instructions on installing and configuring an MVP Server.

These instructions also assume the default install location of MVP software. If you have installed the MVP software elsewhere, please substitute your install location wherever the default location is referenced below.

Initial configurations of GPI preset loads require the use of Windows Explorer and Notepad. GPI preset loads are configured through two files: actions.vssl and gpicfg.vssl

9.2.1. The gpicfg.vssl File

The gpicfg.vssl file maps actions to GPIs. These mapped actions are used to define what the gpi will do (e.g: load a preset).

The syntax for the gpicfg.vssl file can be broken down into three parts:

Part 1: obj GPISource ("DC1")

This defines where the GPIs are connected. When running the Onboard Server, the name of the output card must be set to ("**Local**"), and only the GPIs connected to that card may be used for preset loads. For all other output cards in the system, the GPIs will operate normally.

Part 2: obj gpi(1)

This defines the GPI that will trigger the action (i.e.: the preset load).

Part 3: { action = "presetload" }

The action allows the system to link a GPI to an operation (i.e.: a preset load). The name of the action defined in the gpicfg.vssl will then be called in the actions.vssl file, the second configuration file. The actions.vssl file will define that operation.

Example of a configured gpicfg.vssl file:

```
obj GPISource ("DC1") {  
    obj gpi(1) { action = "presetload" }  
}
```

This configuration maps GPI 1 for DC1 to an action called "preset load".

9.2.2. The actions.vssl File

The actions.vssl file maps actions to a function. These mapped actions are used to define what action will be executed (e.g.: load a preset).

The syntax for the actions.vssl file may be broken down into three parts:

Part 1: obj ActRunScript("presetload")

This defines the name of the action. The name is referenced by gpicfg.vssl

Part 2: script = "preset1.vssl"

This defines the name of the script file (preset) that will be triggered by the action. The script file is created in Maestro during design mode.

Part 3: display = 1

This defines the output that the preset will be loaded on. This is a logical output number.
Example DC1, 1,2,3,4, DC2, 5,6,7,8

Example of a configured actions.vssl file:

```
obj ActRunScript("presetload") {  
    script = "preset1.vssl"  
    display = 1  
}
```

This configuration maps the action "presetload" to the preset "preset1.vssl" which will be loaded on the first output of the first display card in the system.

9.2.3. How to Set Up a GPI Preset Load

Follow the instructions below to set up a preset load.

Part 1: Editing the gpicfg.vssl File

1. From a Windows 2000/XP operating system, using Windows Explorer, browse to the default install location of MVP software:

C:\Program Files\Evertz\MVP\Conductor\Samples

2. Double-click the file called gpicfg.vssl, and then select **Open With** or **Select Program From List**, depending on your operating system.

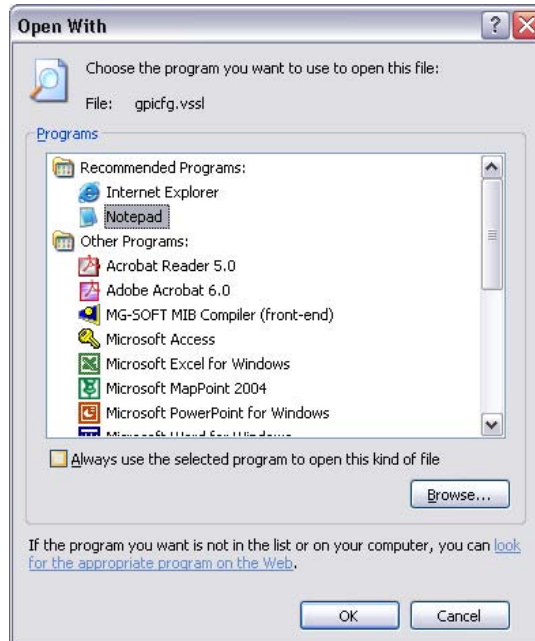

3. Select **Notepad**, and click the checkbox beside **Always use the selected program to open this kind of file** and then click the **OK** button.



Note: When using Notepad, make sure that Word Wrap is disabled. A checkmark appears next to Word Wrap if it is enabled. To disable Word Wrap, click on Word Wrap in the Format menu. This will disable Word Wrap, removing the checkmark.

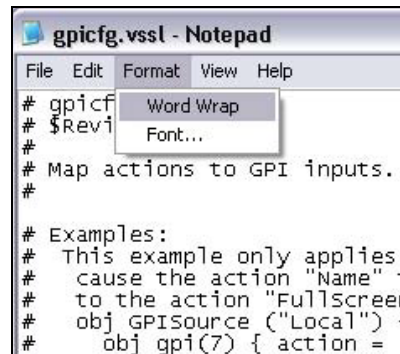

4. When you are finished editing, save the file, making sure that **Save as type** is set to **All Files** from the drop-down list.

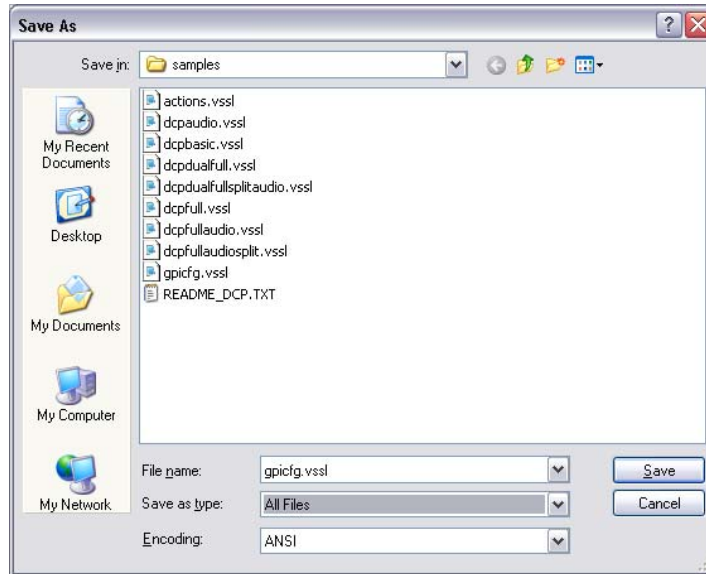

Part 2: Editing the actions.vssl File

1. From a Windows 2000/XP operating system, using Windows Explorer, browse to the default install location of MVP software:
C:\Program Files\Evertz\MVP\Conductor\Samples
2. Double-click the file called actions.vssl, and select **Open With** or **Select Program from List**, depending on your operating system.

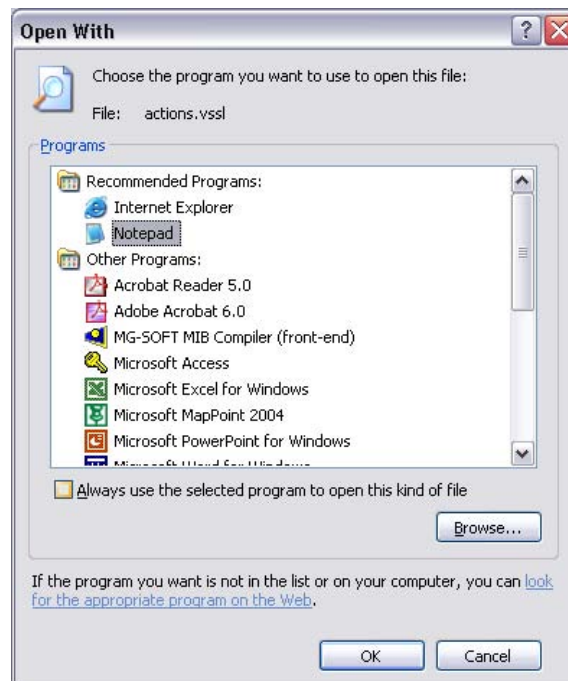

3. Select **Notepad**, and also click the checkbox beside **Always use the selected program to open this kind of file** and then click the **OK** button.



Note: When using Notepad, make sure that word wrap is disabled. A checkmark appears next to Word Wrap if it is enabled. To disable Word Wrap, click on Word Wrap in the Format menu. This will disable Word Wrap, removing the checkmark.

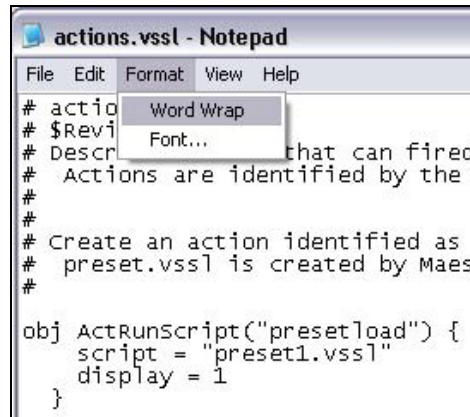

```
actions.vssl - Notepad
File Edit Format View Help
# actio
# $Revi
# Descr
# Actions are identified by the
#
#
# Create an action identified as
# preset.vssl is created by Maest
#
obj ActRunscript("presetload") {
  script = "preset1.vssl"
  display = 1
}
```

4. When you are finished editing, save the file, making sure that **Save as type** is set to **All Files** from the drop-down list.

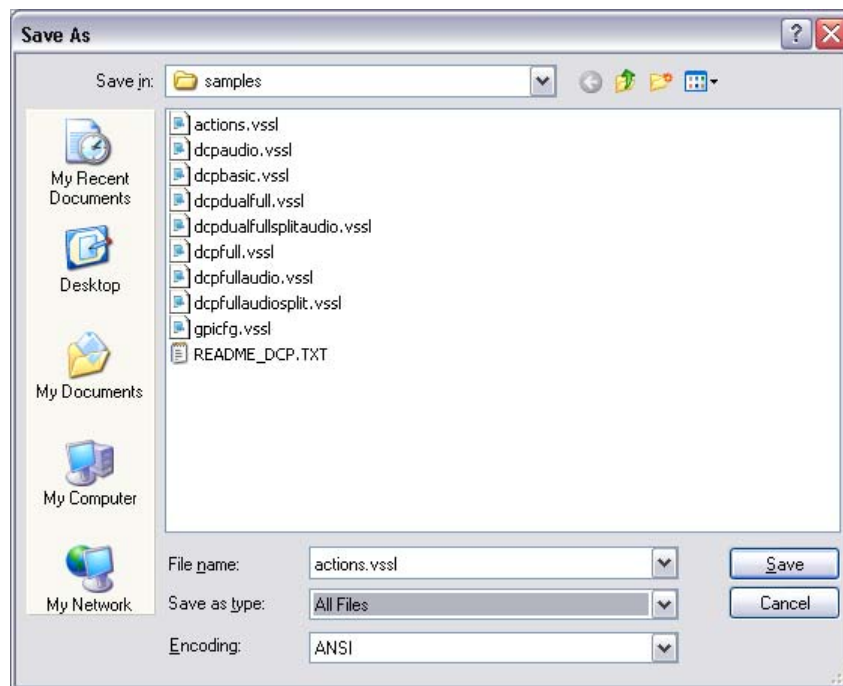

Now that gpicfg.vssl and actions.vssl have been configured and saved, they need to be sent to the server.

Part 3: Verifying Communication with the Onboard Server

1. Launch the **System Configuration Tool** and select the **System Configuration** tab.
2. Select **System Type: Onboard Server** and enter the IP address of the Onboard Server card in the text field as depicted below.

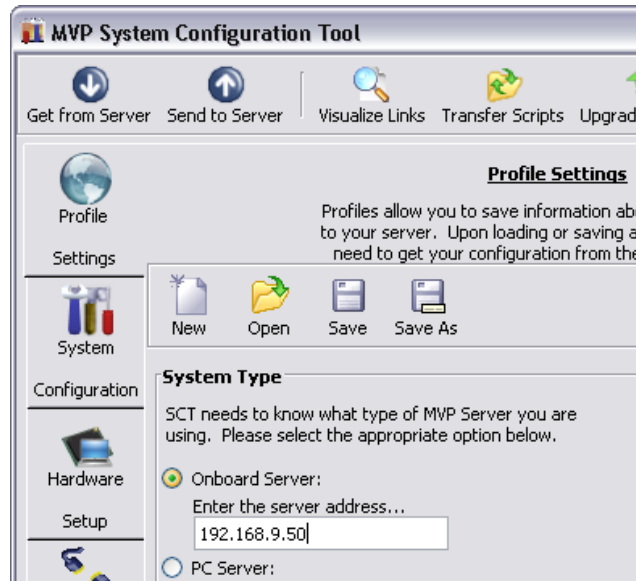

3. Click on **Get from Server** at the top of the **System Configuration Tool** to retrieve configuration and verify communication with the Onboard Server.

Part 4: Transferring the Gpicfg.vssl and Actions.vssl Files Using an Onboard Server

1. Click on **Transfer Scripts**, which will cause the window below to be displayed.



- Click on the  button to open a browse window. Browse to where the `gpicfg.vssl` and `actions.vssl` files were saved.

The default location is **C:\Program Files\Evertz\MVP\Conductor\Samples**

- Select **actions.vssl** and click open. The **Transfer Scripts** menu will appear again.
- From the **Server File** drop-down box, select **Actions**.



- Click on **Send to Server**. The file `actions.vssl` will be sent to the server.
- Click on the  box to open a browse window. Browse to where `gpicfg.vssl` and `actions.vssl` files were saved.

The default location is **C:\Program Files\Evertz\MVP\Conductor\Samples**.

- Select **gpicfg.vssl** and click open. The **Transfer Scripts** menu will appear again.
- From the **Server File** drop-down box, select **GPI Config**.



- Click on **Send to Server**. The file `gpicfg.vssl` will be sent to the server.

The last step is to enable the **GPIId daemon**.

3. Select option **(2) Onboard Server Configuration**

```

-----
|                               Onboard Server Configuration                               |
|                               (3000PPV 2.6.1)                                       |
|-----|
-----
Onboard Server: Enabled
Onboard GPId: Disabled
Onboard VGPIId: Disabled
Onboard DCPd: Disabled
-----
(1) Display connection status
(2) Enable server
(3) Enable gpid
(4) Enable vgpId
(5) Enable dcpd

(S) Save and Exit
(X) Exit

```

Figure 9-14: Onboard Server Configuration Menu

4. Select **(3) Enable gpid** to enable the daemon required to load presets through GPls.

```

-----
|                               Onboard Server Configuration                               |
|                               (3000PPV 2.6.1)                                       |
|-----|
-----
Onboard Server: Enabled
Onboard GPId: Enabled
Onboard VGPIId: Disabled
Onboard DCPd: Disabled
-----
(1) Display connection status
(2) Enable server
(3) Enable gpid
(4) Enable vgpId
(5) Enable dcpd

(S) Save and Exit
(X) Exit
> s
Saving changes..
Please reboot for changes to take effect

```

5. Select **(S) Save and Exit** to save the changes. Reboot the server output card for the changes to take effect.

When the card has been re-booted, GPls may be used to load the defined presets in the **gpifg.vssl** and **actions.vssl** files. Please refer to the Maestro manual for more information on how to create the presets.

9.3. SETTING UP A VGPI PRESET LOAD – OFFBOARD SERVER

VGPIs are virtual GPIs sent by a 7000MVP-PTX or a third-party device adhering to the VGPI protocol format.

Initial configurations of VGPI preset loads require the use of Windows Explorer and Notepad. VGPI preset loads are configured through two files: actions.vssl and picfg.vssl.

Please note that this procedure assumes the MVP Server has already been installed and configured.

These instructions also assume the default install location of MVP software. If you have chosen an alternate install location, please substitute your install location wherever the default location is reference below.

9.3.1. The gpicfg.vssl File

The gpicfg.vssl file maps actions to GPIs. These mapped actions are used to define what the gpi will do.

The syntax for the gpicfg.vssl file can be broken down into three parts:

Part 1: obj GPISource ("DC1"):

This defines where the VGPIs are connected. When running the Offboard Server, this entry must be set to the name of first output card listed in the **Hardware Setup** tab of the **Server Manager**, and only the VGPIs connected to that card maybe used for preset loads. For all other output cards in the system, the VGPIs will operate normally.

Part 2: obj vgpi(1):

This defines the VGPI that will trigger the action, i.e. the preset load.

Part 3: { action = "presetload" }

This action allows the system to link a VGPI to an operation (a preset load). The name of the action defined in the gpicfg.vssl will then be called in the actions.vssl file (the second configuration file). The actions.vssl file will then define that operation.

Example of a Configured “gpicfg.vssl” File

```
obj GPISource ("DC1") {  
  obj vgpi(1) { action = "presetload" }  
}
```

This configuration maps VGPI 1 for DC1 to an action called “preset load”.

9.3.2. The actions.vssl File

The actions.vssl file maps actions to a function. These mapped actions are used to define what the action will do (e.g.: load a preset).

The syntax for the actions.vssl file can be broken down into three parts:

Part 1: `obj ActRunScript("presetload")`

This defines the name of the action. The name is referenced by `gpicfg.vssl`.

Part 2: `script = "preset1.vssl"`

This defines the name of the script file (preset) that will be triggered by the action. The script file is created in Maestro during design mode.

Part 3. `display = 1`

This defines the output that the preset will be loaded on. This is a logical output number (e.g.: DC1 - 1,2,3,4; DC2 - 5,6,7,8)

Example of a configured actions.vssl file

```
obj ActRunScript("presetload") {  
  script = "preset1.vssl"  
  display = 1  
}
```

This configuration maps the action “presetload” to the preset “preset1.vssl”, which will be loaded on the first output of the first display card in the system.

9.3.3. How to Set Up a VGPI Preset Load

Part 1: Editing the gpicfg File

1. From a Windows 2000/XP operating system, using Windows Explorer, browse to the default install location of MVP software:

C:\Program Files\Evertz\MVP\Conductor\Samples

2. Double-click the file called **gpicfg.vssl**, and then select **Open With** or **Select Program from List**, depending on your operating system.

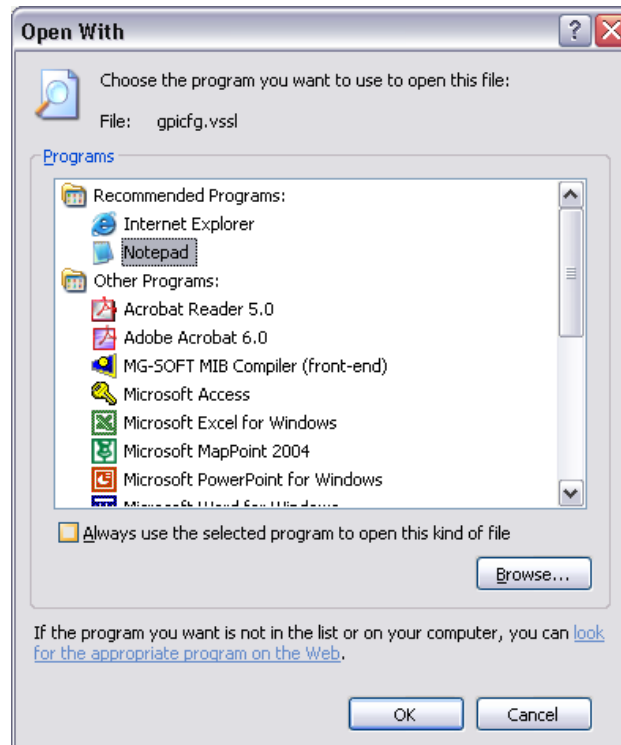

3. Select **Notepad**, and click the checkbox beside **Always use the selected program to open this kind of file** and then click the **OK** button.



Note: When using Notepad, make sure that Word Wrap is disabled. A checkmark appears next to Word Wrap if it is enabled. To disable Word Wrap, click on Word Wrap in the Format menu. This will disable Word Wrap, removing the checkmark.

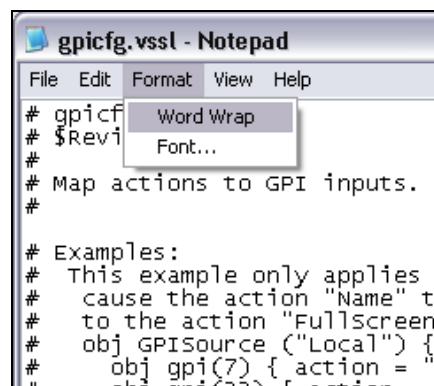

4. When you are finished editing, save the file, making sure that **Save as type** is set to **All Files** from the drop-down list.

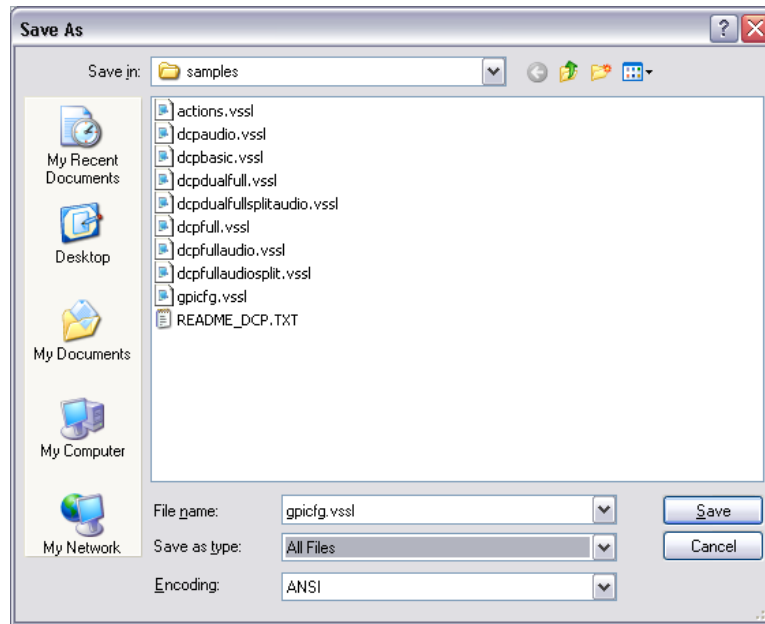

Part 2: Editing the actions.vssl File

1. From a Windows 2000/XP operating system, using Windows Explorer, browse to the default install location of MVP software:
C:\Program Files\Evertz\MVP\Conductor\Samples
2. Double-click the actions.vssl file, and select **Open With** or **Select Program from List**, depending on your operating system.

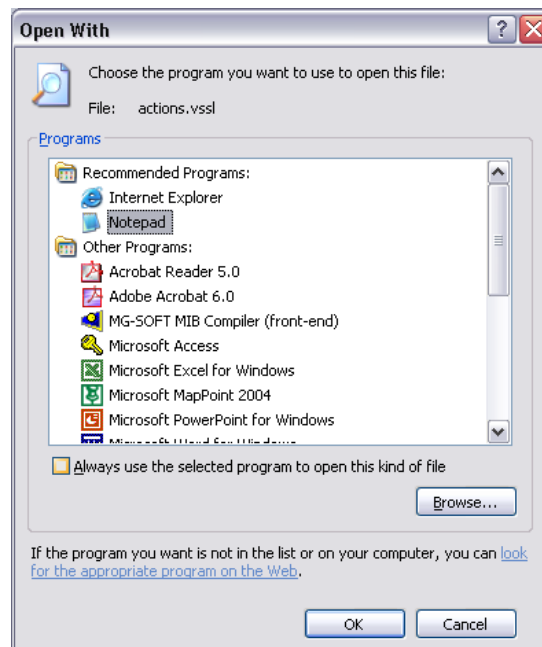

3. Select **Notepad**, and also click the checkbox beside **Always use the selected program to open this kind of file** and the click the **OK** button.



Note: When using Notepad, make sure that Word Wrap is disabled. A checkmark appears next to Word Wrap if it is enabled. To disable Word Wrap, click on Word Wrap in the Format menu. This will disable Word Wrap, removing the checkmark.

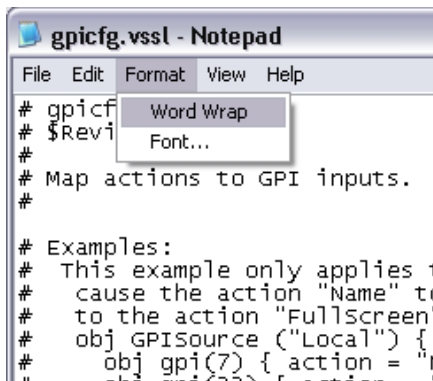

4. When you are finished editing, save the file, making sure that **Save as type** is set to **All Files** from the drop-down list.

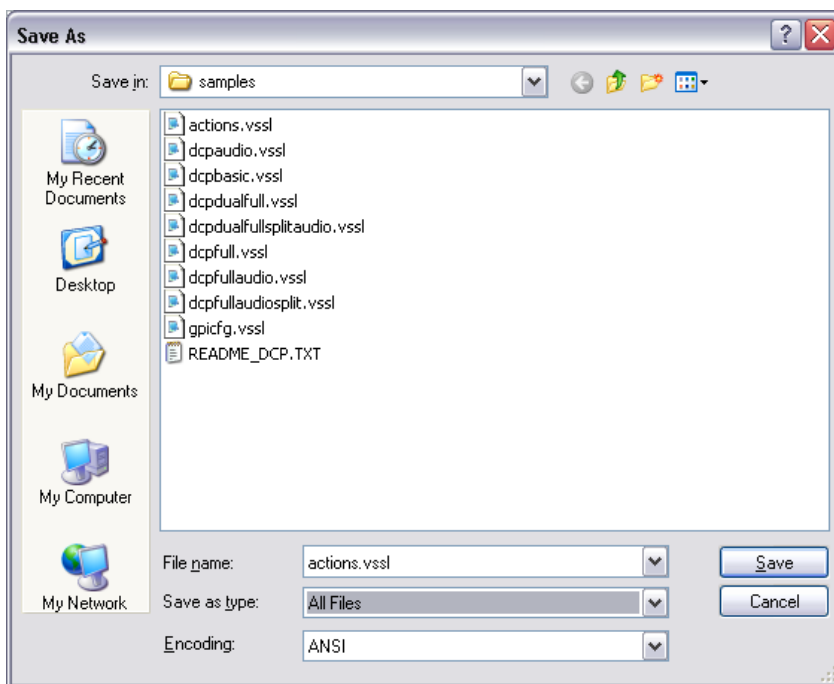

Now that gpicfg.vssl and actions.vssl have been configured and saved, they need to be sent to the server

Part 3: Transferring the Gpicfg.vssl and Actions.vssl Files

1. Launch the **MVP System Manager**, and select the system that will be using VGPI based preset loads.

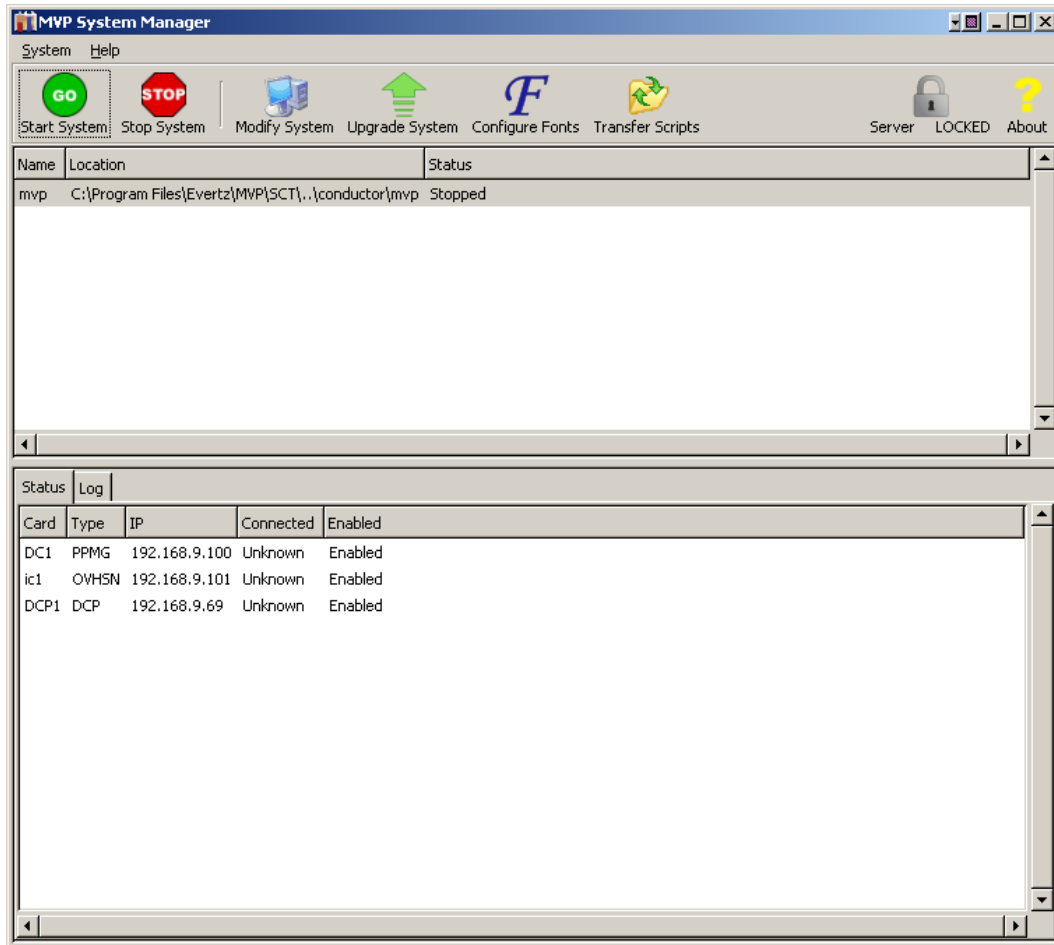

2. Click on **Transfer Scripts**, which will launch the window below.



3. Click on the  button to open a browse window. Browse to where the **gpicfg.vssl** and **actions.vssl** files were saved.

The default location is ***C:\Program Files\Evertz\MVP\Conductor\Samples***

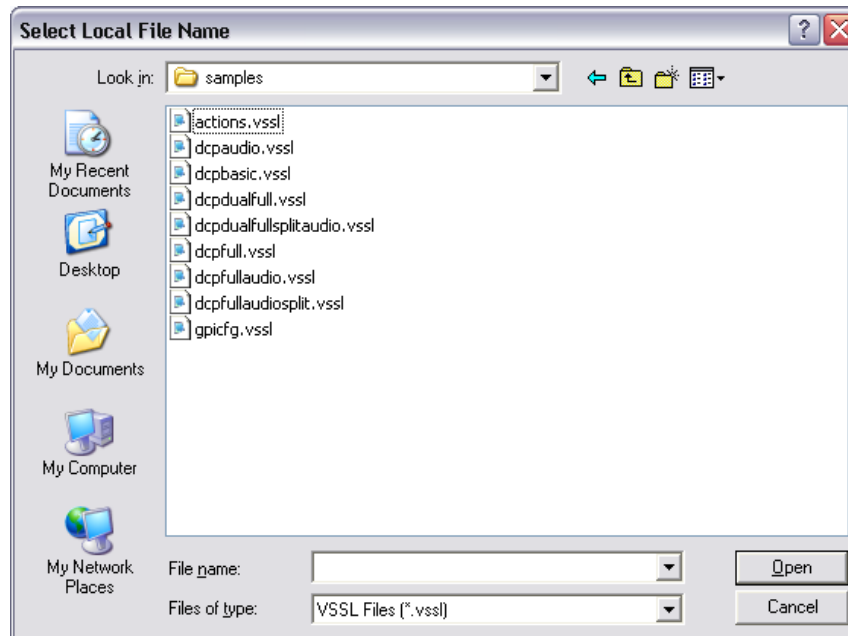

4. Select **actions.vssl** and click open. The Transfer Scripts menu will appear again.
5. Select **Server File**, click on **Actions**.



6. Click on **Send to Server**. The file **actions.vssl** will be sent to the server.
7. Click on the  button to open a browse window. Browse to where **gpicfg.vssl** and **actions.vssl** files were saved.

The default location is **C:\Program Files\Evertz\MVP\Conductor\Samples**.

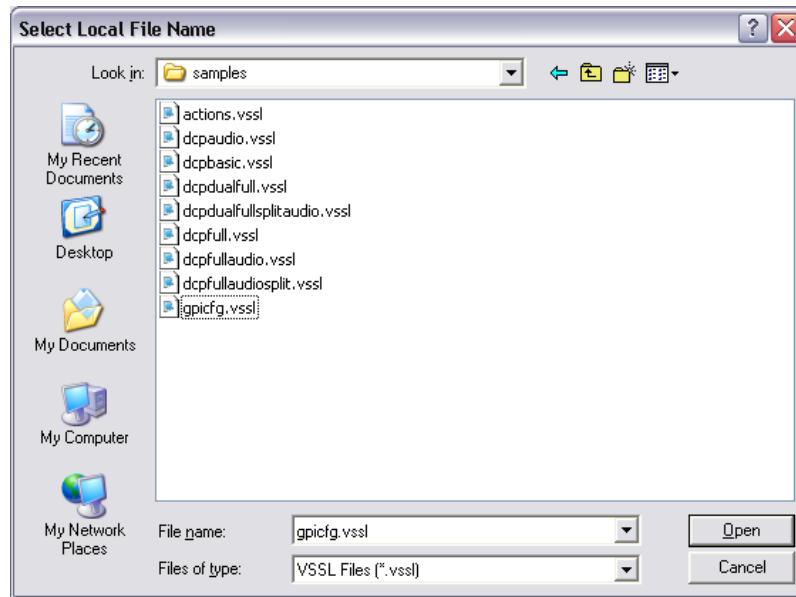

8. Select **gpicfg.vssl** and click open. The Transfer Scripts menu will appear again.
9. Select **Server File**, and then click on **GPI Config**.



10. Click on **Send to Server**. The file gpicfg.vssl will be sent to the server.

The last step is to enable the VGPIId daemon.

Part 4: Enabling the VGPIId Daemon

The ability to load presets on a display is controlled by a daemon called VGPIId that runs in the MVP Server Manager.

This daemon is **only** used to load presets on a display. **It is not required with normal VGPI operation.**

1. Launch the **MVP System Manager**.
2. Click on **Modify System** button.

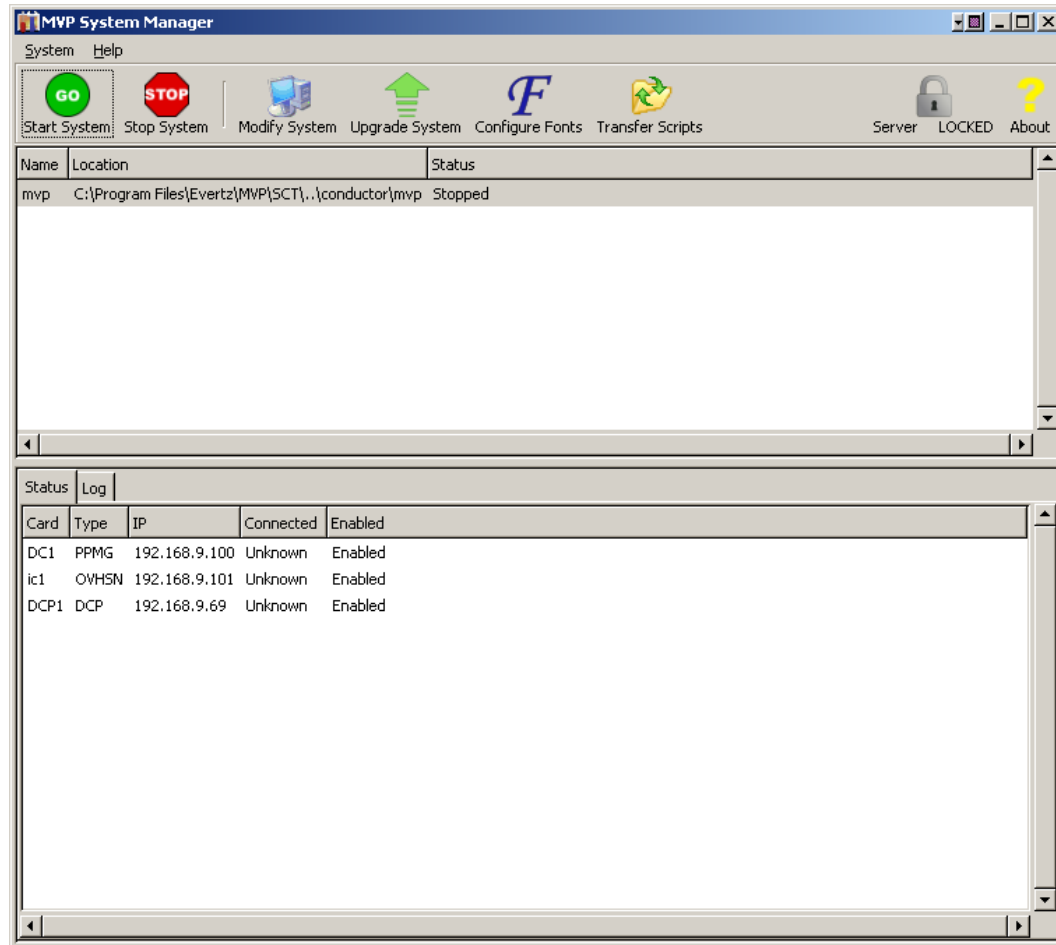

3. Select the **Global Setting** tab, and click the checkbox beside **Use VGPI**.

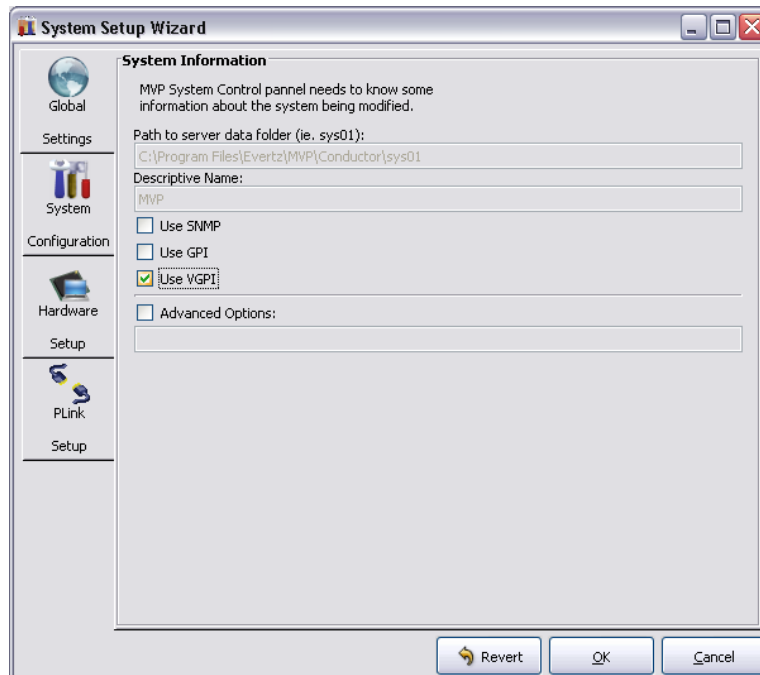

4. When you have completed the selection, click on **OK** to save the changes.

The system will then display the following message:

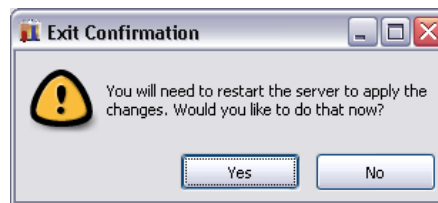

5. Click **Yes** to restart the server.

When the server has been restarted, VGPIs may be used to load the defined presets in the **gpicfg.vssl** and **actions.vssl** files. Please refer to the Maestro manual for information on how to create the presets

9.4. SETTING UP A VGPI PRESET LOAD – ONBOARD SERVER

VGPIs are virtual GPIs sent by a 7000MVP-PTX or a third party device adhering to the VGPI protocol format.

Initial configurations of VGPI preset loads require the use of Windows Explorer and Notepad. VGPI preset loads are configured through two files: **actions.vssl** and **gpicfg.vssl**

Please note that this procedure assumes the MVP Server has already been installed and configured. If you have not already done so, please refer to sections 7.2 and 7.3 for further information.

These instructions also assume the default install location of MVP software. If you have chosen an alternate install location, please substitute your install location wherever the default location is referenced below.

9.4.1. The **gpicfg.vssl** File

The **gpicfg.vssl** file maps actions to VGPIs. These mapped actions are used to define what the VGPI will do (e.g.: load a preset).

The syntax for the **gpicfg.vssl** file can be broken down into three parts:

Part 1: obj GPISource ("Local")

This defines where the VGPIs are connected. With an onboard server, this entry must be set to ("Local"), and only the VGPIs connected to the onboard server card can be used for the preset load. For onboard systems with two output cards, the VGPIs will operate normally for the card not running the server.

Part 2: obj vgpi(1)

This defines the VGPI that will trigger the action (the preset load).

Part 3: { action = "presetload" }

The action allows the system to link a VGPI to an operation (i.e.: a preset load). The name of the action defined in the **gpicfg.vssl** will then be called in the **actions.vssl** file (the second configuration file). The **actions.vssl** file then will define that operation.

Example of a configured **gpicfg.vssl** file

```
obj GPISource ("Local") {  
  obj vgpi(1) { action = "presetload" }  
}
```

This configuration maps VGPI 1 for an onboard server to an action called "preset load".

9.4.2. The **actions.vssl** File

The **actions.vssl** file maps actions to a function. These mapped actions are used to define what the action will do (e.g.: load a preset).

The syntax for the **actions.vssl** file can be broken down into three parts:

Part 1: obj ActRunScript("presetload")

This defines the name of the action. The name is referenced by **gpicfg.vssl**

Part 2: script = "preset1.vssl"

This defines the name of the script file (preset) that will be triggered by the action. The script file is created in Maestro during design.

Part 3: display = 1

This defines the output that the preset will be loaded on. This is a logical output number.

Example of a configured **actions.vssl** file

```
obj ActRunScript("presetload") {  
  script = "preset1.vssl"  
  display = 1  
}
```

This configuration maps the action “presetload” to the preset “preset1.vssl”, which will be loaded on the first output of the first display card in the system.

9.4.3. How to Set Up a VGPI Preset Load

Follow the instructions below to set up a VGPI preset load.

Part 1: Editing the **gpicfg.vssl** File

1. From a Windows 2000/XP operating system, using Windows Explorer, browse to the default install location of MVP software:

C:\Program Files\Evertz\MVP\Conductor\Samples

2. Double-click the file called **gpicfg.vssl**, and then select **Open With** or **Select Program from List**, depending on your operating system.

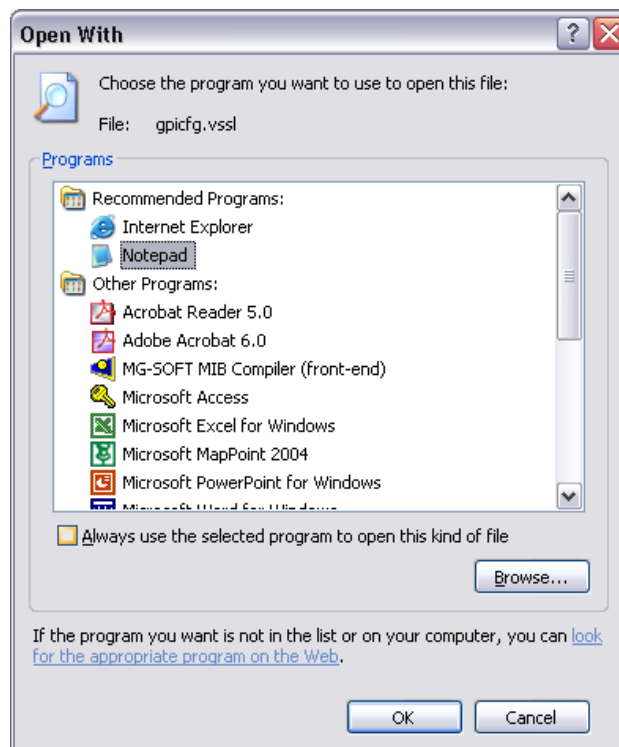

3. Select **Notepad**, and click the checkbox beside **Always use the selected program to open this kind of file** and then click **OK** button.



Note: When using Notepad, make sure that Word Wrap is disabled. A checkmark appears next to Word Wrap if it is enabled. To disable Word Wrap, click on Word Wrap in the Format menu and remove the checkmark.

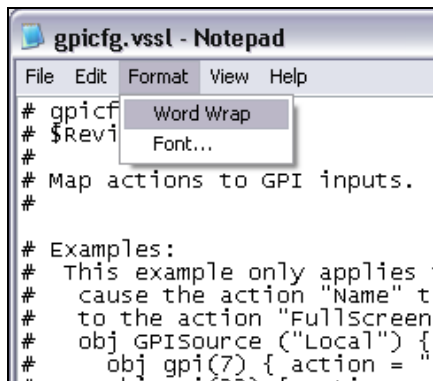

4. When you are finished editing, save the file, making sure that **Save as type** is set to **All Files** from the drop-down list.

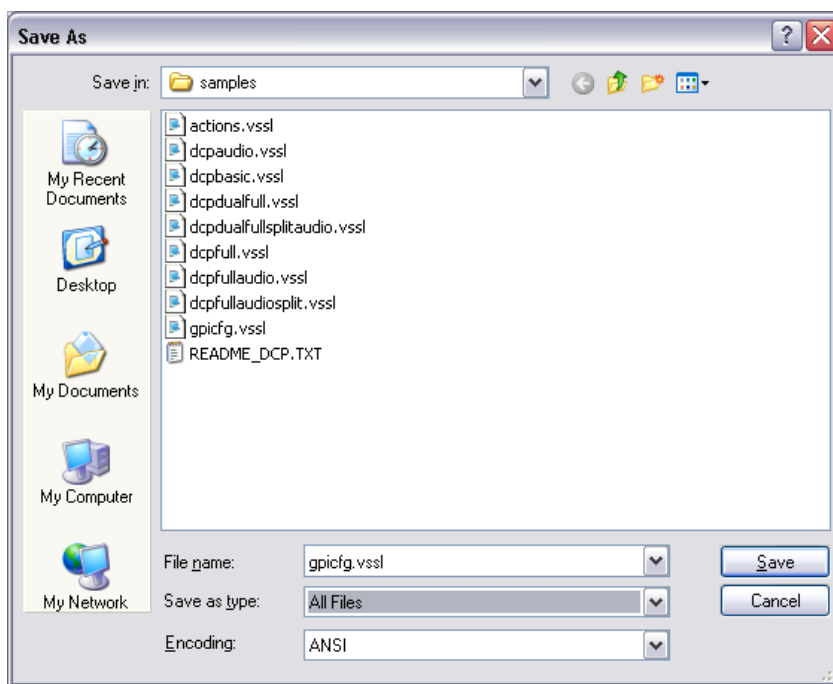

Part 2: Editing the actions.vssl File

1. From a Windows 2000/XP operating system, using Windows Explorer, browse to the default install location of MVP software:
C:\Program Files\Evertz\MVP\Conductor\Samples
2. Double-click the actions.vssl file, and select **Open With** or **Select Program from List**, depending on your operating system.

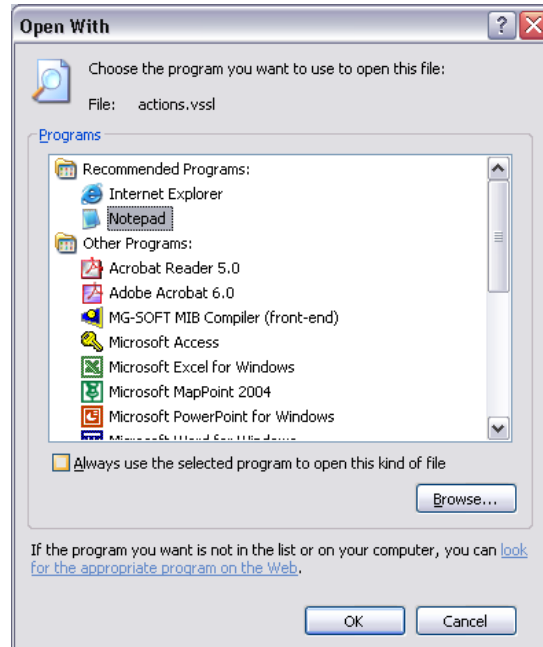

3. Select **Notepad**, and also click the checkbox beside **Always use the selected program to open this kind of file** and then click **OK** button.



Note: When using Notepad, make sure that Word Wrap is disabled. A checkmark appears next to Word Wrap if it is enabled. To disable Word Wrap, click on Word Wrap in the Format menu and remove the checkmark.

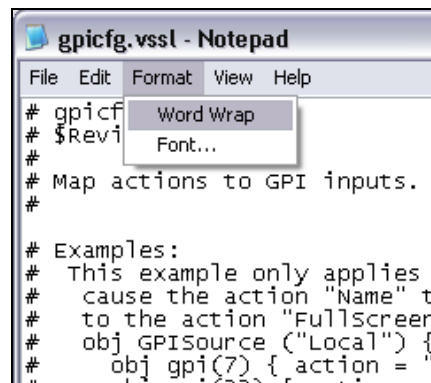

4. When you are finished editing, save the file, making sure that **Save as type** is set to **All Files** from the drop-down list.

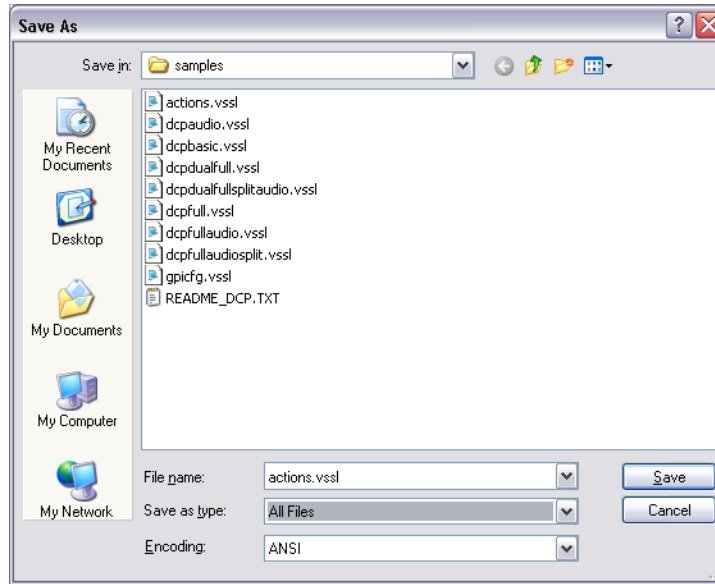

Now that **gpicfg.vssl** and **actions.vssl** have been configured and saved, they need to be sent to the server

Part 3: Verifying Communication with the Onboard Server

1. Launch the **System Configuration Tool** and select the **System Configuration** tab.
2. Select **System Type: Onboard Server**. Enter the IP address of the onboard server card in the text field as depicted below.

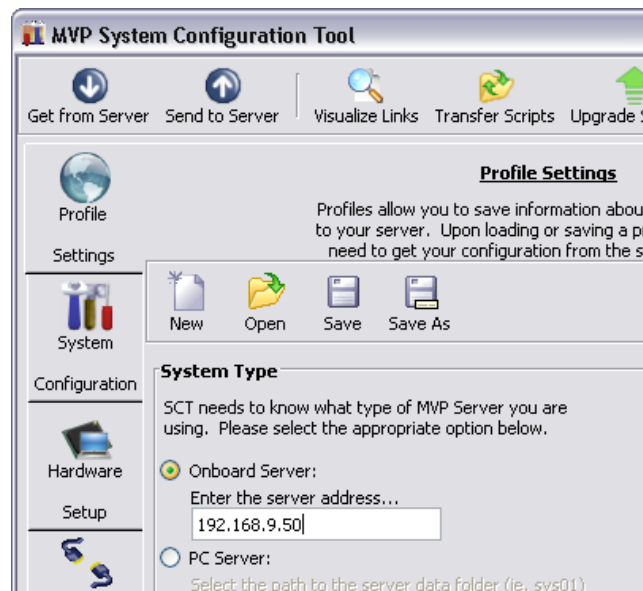

3. Click on **Get from Server** at the top of the **System Configuration Tool** to retrieve configuration and verify communication with the Onboard Server.

Part 4: Transferring the Gpicfg.vssl and Actions.vssl Files Using an Onboard Server

1. Click on **Transfer Scripts**, which will cause the window below to be displayed.



2. Click on the  button to open a browse window. Browse to where the gpicfg.vssl and actions.vssl files were saved.

The default location is **C:\Program Files\Evertz\MVP\Conductor\Samples**.

3. Select **actions.vssl** and click open. The **Transfer Scripts** menu will appear again.
4. From the **Server File** drop-down menu, select **Actions**.



5. Click on **Send to Server**. The file **actions.vssl** will be sent to the server.
6. Click on the  button to open a browse window. Browse to where the gpicfg.vssl and actions.vssl files were saved.

The default location is **C:\Program Files\Evertz\MVP\Conductor\Samples**.

7. Select **gpicfg.vssl** and click open. The **Transfer Scripts** menu will appear again.
8. From the **Server File** drop-down menu, select **GPI Config**.



9. Click on **Send to Server**. The file **gpicfg.vssl** will be sent to the server.

The last step is to enable the **VGPIId daemon**

Part 5: Enabling VGPIId Daemon on the Onboard Server

The ability to load presets on a display is controlled by a daemon called **“VGPIId”**, running on the server output card.

This daemon is *only* used to load presets on a display. **It is not required with normal VGPI operation.**



The next few steps require a PC with HyperTerminal, a serial port, a serial cable, and a serial upgrade cable.

- 1. Attach the serial upgrade cable to the server output card and launch HyperTerminal as outlined in the MVP Manual.
- 2. Once connected with HyperTerminal, hit <ENTER> to display the serial menu of the server output card.

```

      Main Menu
      (3000PPV 2.6.1)

(1) Network Configuration
(2) Onboard Server Configuration
(3) Utilities
(4) Under Monitor Display Setup
(5) Auxiliary Serial Port Setup
(6) Display Wall Test
(7) Hardware Test Menu
(8) Engineering/Debug

(X) Exit
  
```

3. Select **(2) Onboard Server Configuration**.

```

-----
|                               |
|           Onboard Server Configuration           |
|                               |
|           (3000PPV 2.6.1)           |
|                               |
-----

```

```

-----
Onboard Server: Enabled
Onboard GPID: Disabled
Onboard VGPIID: Disabled
Onboard DCPD: Disabled
-----

```

```

-----
(1) Display connection status
(2) Enable server
(3) Enable gpid
(4) Enable vgpId
(5) Enable dcpd

(S) Save and Exit
(X) Exit
-----

```

4. Select **(3) Enable vgpId** to enable the daemon required to load presets through VGPIs.

```

-----
|                               |
|           Onboard Server Configuration           |
|                               |
|           (3000PPV 2.6.1)           |
|                               |
-----

```

```

-----
Onboard Server: Enabled
Onboard GPID: Disabled
Onboard VGPIID: Enabled
Onboard DCPD: Disabled
-----

```

```

-----
(1) Display connection status
(2) Enable server
(3) Enable gpid
(4) Enable vgpId
(5) Enable dcpd

(S) Save and Exit
(X) Exit
-----

```

```

> s
Saving changes..
Please reboot for changes to take effect
-----

```

5. Select **(S) Save and Exit** to save the changes. Reboot the server output card for the changes to take effect.

When the card has been re-booted, VGPIs may be used to load the defined presets in the **gpIcIlg.vssI** and **actIons.vssI** files. Please refer to the Maestro manual for instructions on how to create the presets.

10. SETTING UP PROTOCOLS

Sections 10.1 to 10.4 explain how to set up the following protocols on the MVP system:

- Image Video Protocol
- TSL Protocol
- X-Y Protocol
- ASCII Protocol

Only set up the protocols that are relevant to your system.

10.1. SETTING UP MVP TO WORK WITH IMAGE VIDEO PROTOCOL

1. Select either RS-422 or RS-232 serial operation by setting jumpers J33 and J34 to one of these two positions on the auxiliary daughter card of the display card.
2. Power up the system.
3. Set up the auxiliary (rear) serial port baud rate to match the router/switcher device.

This is performed via the upgrade serial port on the front of the card.

4. Select **(5) Auxiliary Serial Port Setup** from the main menu of the terminal program.

Ensure the settings match those listed below:

```
-----  
|           Auxiliary Serial Port Setup           |  
|           (3000PPV v1.06 b1248)               |  
-----  
Baud Rate:           115200  
Data Bits:           8  
Parity:              None  
Stop Bits:           2  
-----  
(1) Set baud rate  
(2) Set number of data bits  
(3) Set parity  
(4) Set number of stop bits  
  
(S) Save and Exit  
(X) Exit  
>
```

Figure 10-1: Auxiliary Port Setup Menu

5. Select **(4) Under Monitor Display Setup** from the main menu to set up the display card for Image Video protocol operation.

```
-----  
|           Under Monitor Display Setup           |  
|           (3000PPV v1.06 b1248)                |  
-----  
Protocol:      Image Video  
Input Type:    serial  
-----  
(1) Set protocol  
  
(S) Save and Exit  
(X) Exit  
>
```

Figure 10-2: Under Monitor Display Setup

6. Wire the serial connection from the router/switcher to the auxiliary serial port of the MVP.
7. Power-cycle the MVP frame.
8. Using Maestro, add a UMD to a video object by dragging and dropping it onto the video object.
9. In **Mode Settings > Mode > Function**, select Protocol ID from the drop-down box.
10. Set the Active Protocol ID to match the video mapping defined by the router/switcher.

When the MVP receives a command from the router/switcher it will now be displayed on the output display.

10.2. SETTING UP MVP TO WORK WITH TSL PROTOCOL

1. Select RS-422 serial operation by setting jumpers J33 and J34 to this position on the auxiliary daughter card on the display card.
2. Power up the system.
3. Set up the auxiliary (rear) serial port baud rate to match the router/switcher device.

This is performed via the upgrade serial port on the front of the card.

4. Select **(5) Auxiliary Serial Port Setup** from the main menu of the terminal program.

Ensure the settings match those listed below:

```
-----  
|           Auxiliary Serial Port Setup           |  
|           (3000PPV v1.06 b1248)               |  
-----  
Baud Rate:           38400  
Data Bits:           8  
Parity:              even  
Stop Bits:           1  
-----  
(1) Set baud rate  
(2) Set number of data bits  
(3) Set parity  
(4) Set number of stop bits  
  
(S) Save and Exit  
(X) Exit  
>
```

Figure 10-3: Auxiliary Serial Port Settings

5. Select **(4) Under Monitor Display Setup** from the main menu to set up the display card for TSL protocol operation.

Ensure the settings match those listed below:

```
-----  
|           Under Monitor Display Setup           |  
|           (3000PPV v1.06 b1248)               |  
-----  
Protocol:            TSL  
Input Type:          serial  
-----  
(1) Set protocol  
  
(S) Save and Exit  
(X) Exit  
>
```

Figure 10-4: Under Monitor Display Setup Settings

6. Wire the serial connection from the router/switcher to the auxiliary serial port of the MVP, located on the 3000BHP-AUX breakout panel.

The 3000BHP-AUX is connected via the SCSI cable to the back of the display card in the MVP frame.

Connect the device providing the TSL data to the MVP 3000BHP-AUX as follows:

TSL Source <i>function</i>	MVP 3000BHP-AUX	
	<i>Pin #</i>	<i>Label</i>
GND	4	GND
Tx+	6	CTS
Tx-	8	RX

7. Power-cycle the MVP frame.
8. Using Maestro, add a UMD to a video object by dragging and dropping it onto the video object.
9. Navigate to **Mode Settings > Mode > Function**, and select **Protocol ID** from the drop-down box.
10. Set the Active Protocol ID to match the video mapping defined by the router/switcher.

When the MVP receives a command from the router/switcher it will now be displayed on the output display.

10.3. SETTING UP MVP TO WORK WITH X-Y PROTOCOL

Use the following set of instructions to configure the MVP to use the X-YI protocol.

10.3.1. Creating the Text Files

1. Create two text files named "router_src.cfg" and "router_dst.cfg", and save both files to the compact flash card on the display card(s) in the MVP system.

Please use the following example to create these two files:

```
router_src.cfg
```

#	src id	string
0		"name 1"
1		"name 2"
2		"name 3"
3		"name 4"

Example:

Sample router_src.cfg file:

```
0 name1
1 name2
2 name3
3 name4
```

router_dst.cfg

# umd	protocol id	dst id
0		1
1		2
2		3

Figure 10-5: Sample Text Files

Example:

Sample router_dst.cfg file:

```
0 1
1 2
2 3
```

2. FTP both files to the compact flash cards of all display cards in the system:

```
C:\ftp "ip address of display card"
ftp>put router_src.cfg
ftp>put router_dst.cfg
ftp>quit
```

10.3.2. Setting Up the Display Card(s)

1. Select either RS-422 or RS-232 serial operation by setting jumpers J33 and J34 to one of these two positions on the auxiliary daughter card of the display card.
2. Power up the system.
3. Set up the auxiliary (rear) serial port baud rate to match the router/switcher device.
4. This is performed via the upgrade serial port on the front of the card.
5. Select **(5) Auxiliary Serial Port Setup** from the main menu of the terminal program.

Ensure the settings match those listed below:

```
-----  
|           Auxiliary Serial Port Setup           |  
|           (3000PPV v1.06 b1248)               |  
-----  
Baud Rate:           9600  
Data Bits:           8  
Parity:              None  
Stop Bits:           1  
-----  
(1) Set baud rate  
(2) Set number of data bits  
(3) Set parity  
(4) Set number of stop bits  
  
(S) Save and Exit  
(X) Exit  
>
```

Figure 10-6: Auxiliary Serial Port Setup

6. Select **(4) Under Monitor Display Setup** from the main menu to set up the display card for XY Integrator protocol operation.

```
-----  
|           Under Monitor Display Setup         |  
|           (3000PPV v1.06 b1248)             |  
-----  
Protocol:           XY Integrator  
Input Type:         serial  
-----  
(1) Set protocol  
  
(S) Save and Exit  
(X) Exit  
>
```

Figure 10-7: Setting up XY Integrator Protocol Operation

7. Wire the serial connection from the router/switcher to the auxiliary serial port of the MVP. Refer to the MVP manual for details on this procedure.
8. Power-cycle the MVP frame.
9. Using Maestro, add a UMD to a video object by dragging and dropping it onto the video object.
10. Navigate to **Mode Settings > Mode > Function**, and select **Protocol ID** from the drop-down box.
11. Set the Active Protocol ID to match the video mapping defined by the router/switcher.

When the MVP receives a command from the router/switcher it will now be displayed on the output display.

The command that we expect to see is as follows:

```
S:02,0      = 02:  level 0, destination 2
           = ,1:  source 1
```

Figure 10-8: Command Displayed on the Output Display

Therefore, using the above files as an example – we would display at UMD protocol id 1, the text string “name 2”

10.4. SETTING UP MVP TO WORK WITH ASCII PROTOCOL

10.4.1. Creating the Text File

1. Create a text file named “router.cfg” and save it to the compact flash on the display card.

Use the following example to setup the file:

# Input id	String
0	Source 0
1	Source 1
2	Source 2
3	Evertz MVP

Sample:

```
0 Source0
1 Source1
2 Source2
3 EvertzMVP
```

2. FTP the file to the compact flash cards of all display cards in the system:

```
C:\ftp "IP address of display card"
ftp>put router.cfg
ftp>quit
```

10.4.2. Setting Up the Display Card(s)

1. Select either RS-422 or RS-232 serial operation by setting jumpers J33 and J34 to one of these two positions on the auxiliary daughter card of the display card.
2. Power up the system.
3. Set up the auxiliary (rear) serial port baud rate to match the router/switcher device.

This is performed via the upgrade serial port on the front of the card.

4. Select **(5) Auxiliary Serial Port Setup** from the main menu of the terminal program.

Ensure the settings match those listed below:

```
-----  
|           Auxiliary Serial Port Setup           |  
|           (3000PPV v1.06 b1248)              |  
-----  
Baud Rate:      115200  
Data Bits:      8  
Parity:         None  
Stop Bits:      2  
-----  
(1) Set baud rate  
(2) Set number of data bits  
(3) Set parity  
(4) Set number of stop bits  
  
(S) Save and Exit  
(X) Exit  
>
```

Figure 10-9: Auxiliary Serial Port Setup Menu

5. Select **(4) Under Monitor Display Setup** from the main menu to set up the display card for ASCII protocol operation.

```
-----  
|           Under Monitor Display Setup         |  
|           (3000PPV v1.06 b1248)            |  
-----  
Protocol:      Philips ASCII  
Input Type:    serial  
-----  
(1) Set protocol  
  
(S) Save and Exit  
(X) Exit  
>
```

Figure 10-10: Under Monitor Display Setup Menu

6. Wire the serial connection from the router/switcher to the auxiliary serial port of the MVP.
7. Power-cycle the MVP frame.
8. Using Maestro, add a UMD to a video object by dragging and dropping it onto the video object.
9. Navigate to **Mode Settings > Mode > Function**, and select **Protocol ID** from the drop-down box.

10. Set the Active Protocol ID to match the video mapping defined by the router/switcher.

When the MVP receives a command from the router/switcher it will now be displayed on the output display.

This page left intentionally blank

11. CREATING A REDUNDANT BACKUP OF AN OUTPUT CARD

Creating a redundant back-up of identical output cards allows you to hot-swap output cards quickly and easily, allowing the system to return to its working state.



CAUTION: Redundant back-up cards *must* be kept on the shelf and *not* in the frame. Because both cards have the same IP address, leaving the card in the frame could cause system instability.

Complete the following steps using the **Primary Output Card**:

Part 1: Obtaining the Server Configurations

1. Use the RS-232/422 connection to the output card with HyperTerminal (or preferred RS-232/422 client).
2. Make note of:
 - IP address
 - UMD settings (Protocol, type, etc)
3. Launch the System Configuration tool.
4. Enter the Primary Output Card's IP address.
5. Click the **Get From Server** button.
6. Click the **Transfer Scripts** button.
7. Click on the  button to browse to the desired save location for the server configurations.

Note: These files will be .vssl files.

8. Repeat steps 5-7 for each type being used.
9. When finished, do not close this program, as it will store these settings for the output card.

Part 2: Retrieving Scripts Saved on the Output Card

1. Open a DOS window by selecting **Start > Run**, and typing "cmd".
2. In the DOS window that appears, type "ftp", followed by the IP address of the output card that is running the server and click <ENTER>.
3. When prompted for a username and password, press <ENTER> for both.
4. Type "cd server/scripts"

5. Type “dir”.
6. Type “get”, followed by the filename and location where you want to save these scripts.

For example:

```
get sample.vssl c:\sample.vssl
```

7. Repeat steps 4-6 for each script.
8. When finished, type “bye” to close the session.

Now remove the primary output card from the MVP and insert the redundant output card.

Complete the following steps using the **Redundant Output Card**:

Part 3: Setting Up the Redundant Output Card

1. Use the RS-232/422 connection to output card with HyperTerminal (or preferred RS-232/422 client).
2. Set the card's IP address to the same one as the primary output card.
3. Set UMD protocol, speed, etc. the same as was used for the primary output card.
4. In DOS command prompt, type following:

```
arp -d <IP address of Primary Output Card (that was removed from the frame)>
```

```
e.g.: arp -d 192.168.9.50
```

This will clear the MAC address settings from windows so SCT can connect to the new card even though the IP addresses are the same.

Part 4: Sending Server Settings to Redundant Output Card

1. Using the System Configuration Tool, send the server settings to the Redundant Output Card.

These settings are:

- types of cards in system
- plink setup
- general overall system settings

2. Click on the **Transfer Scripts** button to transfer scripts such as action, gpi, etc., to the redundant output card.



Note: These scripts will be the ones that you saved from the Primary Output card earlier.

Part 5: Completing Set Up of Redundant Output Card

1. Start Maestro and connect to the system.
2. Select **Tools > System Configuration**.
3. Select the Output Card.
4. Click the **Resolution** tab.
5. Select the appropriate resolution from your application.
6. Click **Apply**.
7. Right click on the display and choose **Load Preset**. When the preset has been loaded, click on **File> Save As Script**.

This will ensure the “server/scripts” dir is created on the Redundant Output Card. You can later delete this test script when using DOS FTP.

8. Using DOS FTP, log into the MVP (which will use the same IP address as the output card) and upload the scripts that you have downloaded and saved to your hard drive from the Primary Output card to the location “server/scripts”.

For example:

```
put c:\sample.vssl
```

9. Power-cycle the MVP to ensure that all the new settings on Redundant Output Card load.
10. Test the system and check that all functions are working.

You can now hot-swap cards and have the MVP return to its working state.

This page left intentionally blank

12. ENABLING CLOSED CAPTIONING DECODE

This section requires that a configuration of the embedded MVP server has been uploaded and is running. If you have not already completed this configuration, please complete the steps detailed in section 7 prior to attempting the procedure below.

Also before starting this procedure, make sure that the current MVP layouts (presets) are available. Before rebooting the MVP, be sure to Save System Settings in Maestro to ensure that the current layouts are reloaded after the MVP system has been rebooted.

To set up the current system to support Closed Captioning Decode, follow the instructions below.

12.1. PART 1: CHANGING THE SERVER SETTINGS

1. Double-click the MVP **System Configuration Tool** icon on the desktop.
2. In the **Profile Settings** tab, enter the IP address of the display card in the system on which the embedded MVP server is running.

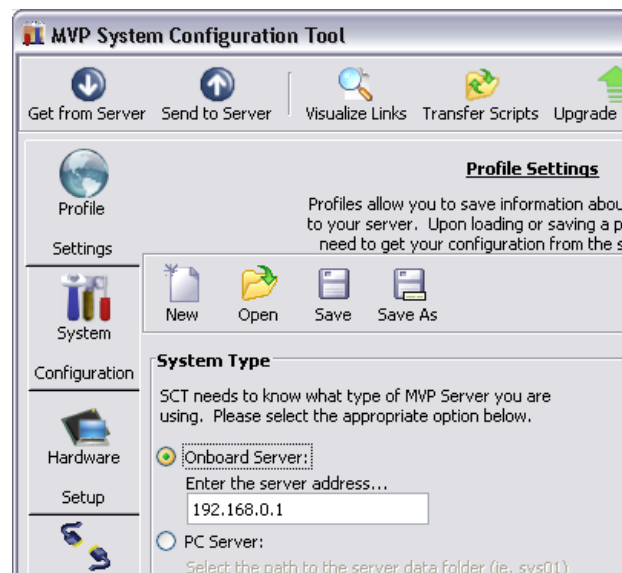

Figure 12-1: Onboard Server IP Address

3. Click the **Get from Server** button. This will connect to the server and retrieve the current system settings.
4. Select the **Hardware Setup** tab.
5. Highlight the input card that will be used to decode the Closed Captioning, and then click on the **Properties** button.

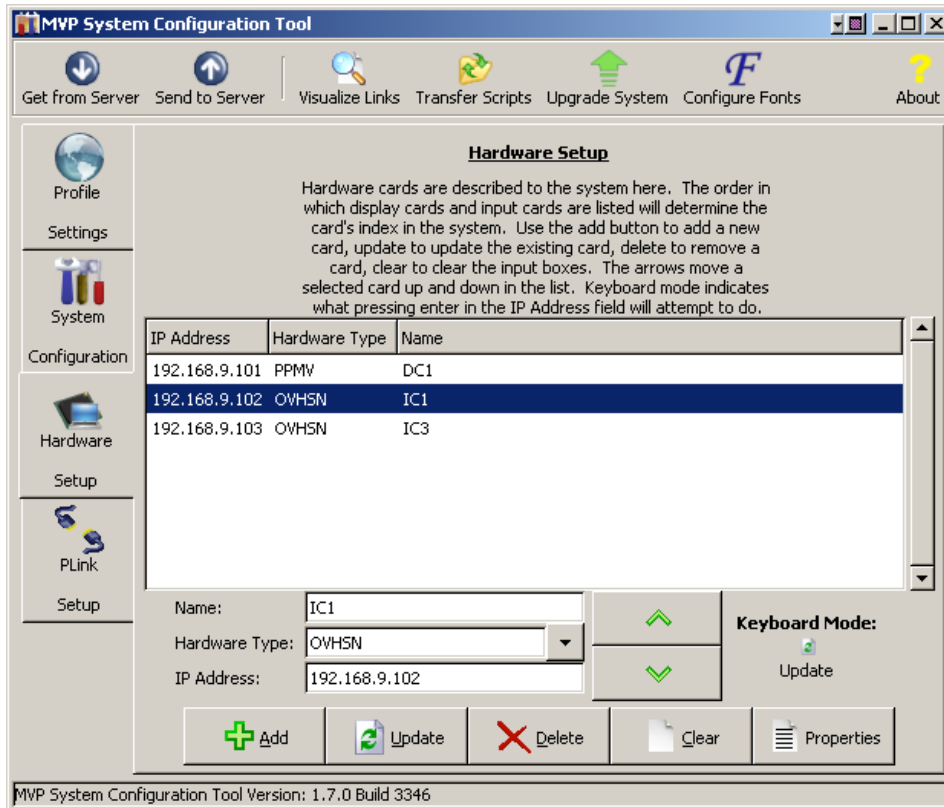

Figure 12-2: Hardware Settings

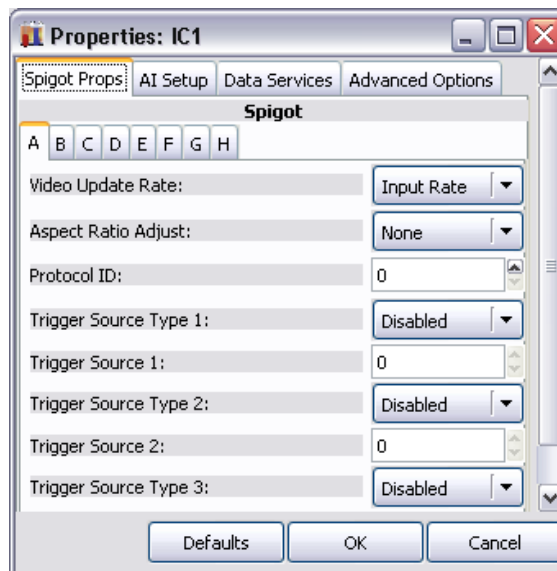

Figure 12-3: Properties

6. In the **Properties** window, select the **Data Services** Tab.

12.2. PART 2: CONFIGURING THE CLOSED CAPTIONING PROPERTIES

There are subtle differences depending on whether you are using 608 closed captioning, 708 closed captioning, or Teletext (the European version of closed captioning). Only one closed captioning mode is supported on the input card at a time. The card is not capable of mixing 608, 708, or Teletext captioning.

12.2.1. 608 Closed Captioning Decode

608 closed captioning is available for the SN, SNX, HSN, and OVN models.

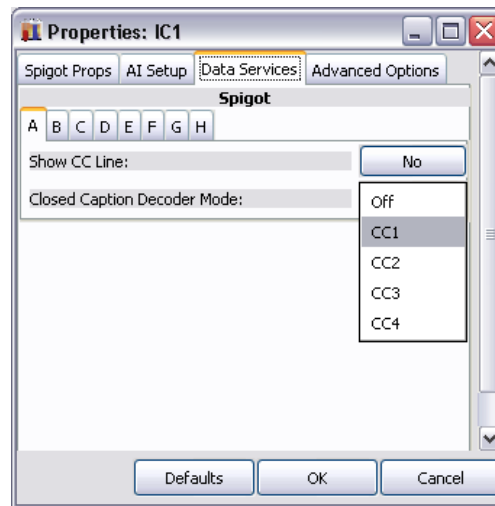

Figure 12-4: 608 Properties

1. Select the input for which Closed Captioning decode is required.
2. Select the Closed Captioning Decoder mode, CC1-CC4.
3. When you have completed the above steps, click OK.

12.2.2. 708 Closed Caption Decode

708 closed caption decode is available only on the HSN model.

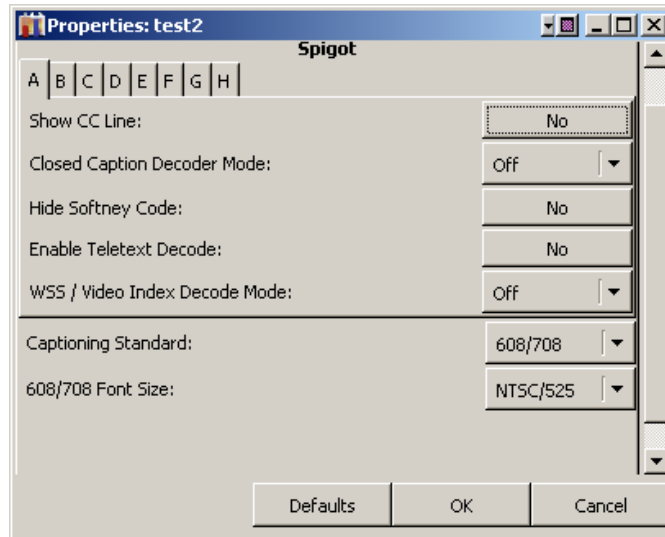

Figure 12-5: 708 Properties

1. Select the input for which Closed Captioning decode is required.
2. Select the Closed Captioning Decoder mode (708 SVC 1- 17).
3. Select the 608/708 Font Size (720 with 720p video and 1080 with 1080i).



Note: The input card is not capable of supporting both 720p and 1080i captioning at the same time.

4. When you have completed the above steps, click OK.

12.2.3. Teletext

Teletext is available for the OVSNX and OVHSN models.

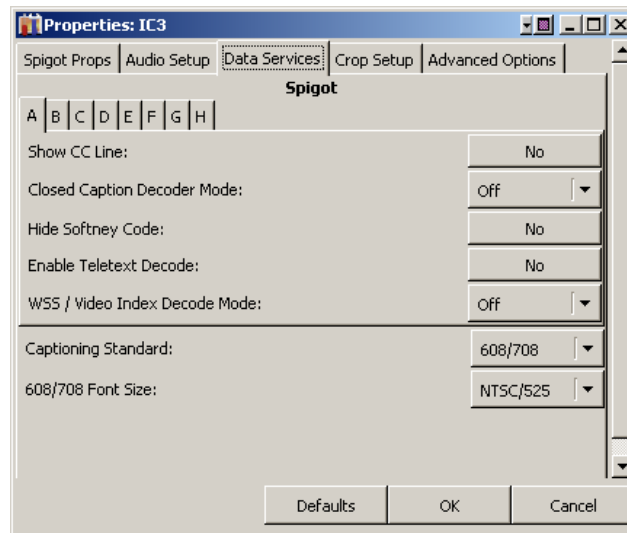

Figure 12-6: Teletext Properties

1. Select the input for which Teletext decode is required.
2. Enable Teletext Decode.
3. Select **Teletext** as the **Captioning Standard**.
4. When you have completed the above steps, click OK.

For the closed captioning/Teletext settings to be applied to the server, the settings must be sent to the server and the server must be restarted.

12.3. PART 3: SENDING THE SETTINGS TO THE SERVER

1. To transfer the changed settings to the server, click on the **Send to Server** button at the top of the main window. This will send all the changes to the server, overwriting the old settings.
2. When the settings have been transferred, reboot the server so the settings take effect.

12.4. PART 4: STARTING MAESTRO AND ENABLING CLOSED CAPTIONING DECODE

1. Double click the **Launch Maestro Design Tool** icon on your desktop.



The MVP Maestro Design splash screen will appear briefly as the software loads.

2. When the software is loaded, a login dialog box will appear. You must enter a username and password in order to gain access to the program.

The default username is "admin", with no password. Type "admin" in the **User Name** field and press <ENTER>.

3. Once you have reached the System Manager screen, select the correct system and double-click to enter the Display Manager.

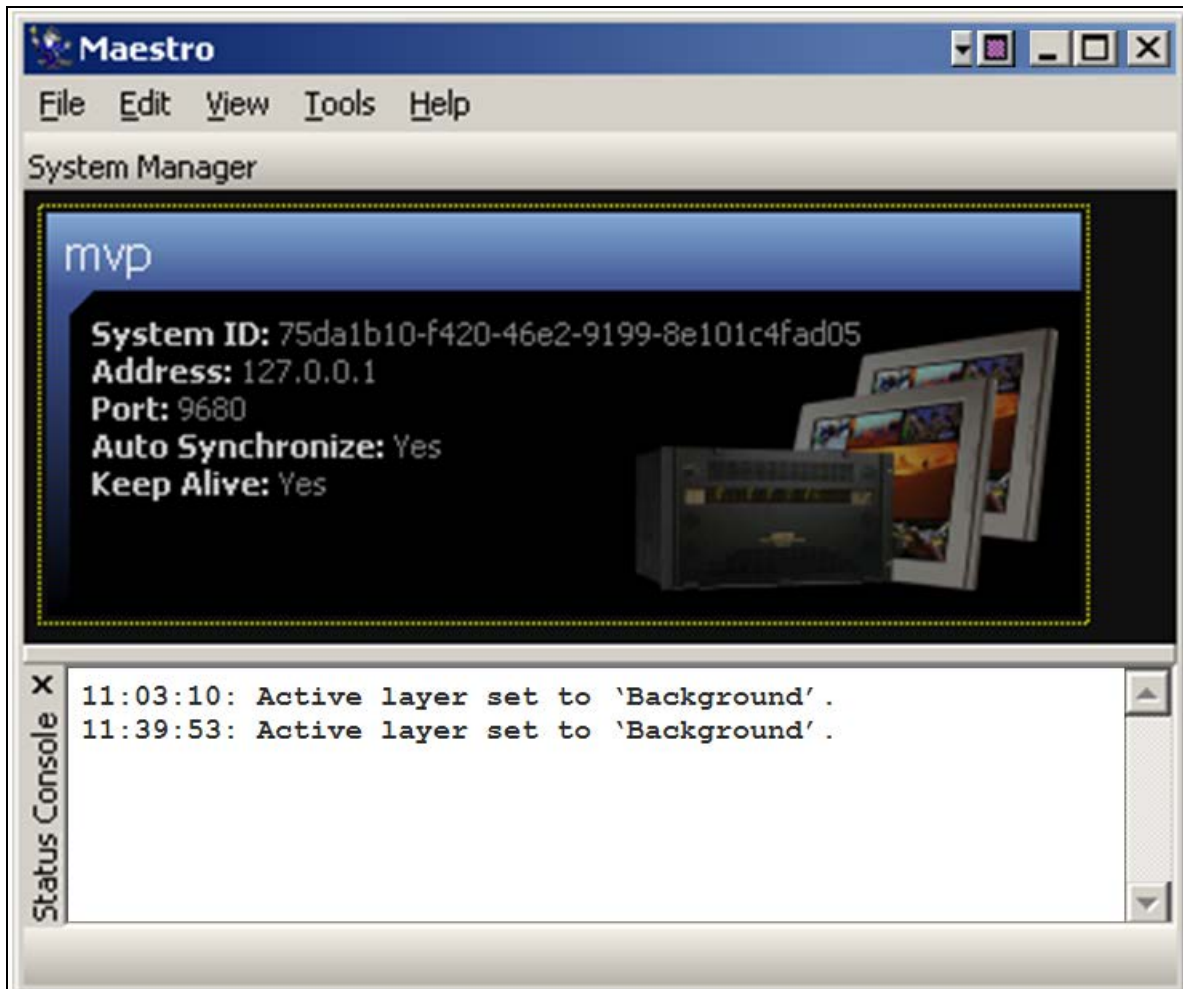

Figure 12-7: System Manager

4. Connect to the system by clicking the connect button in the toolbar (looks like a plug), and then select the correct output display that will have the input source that requires Closed Captioning Decoding.

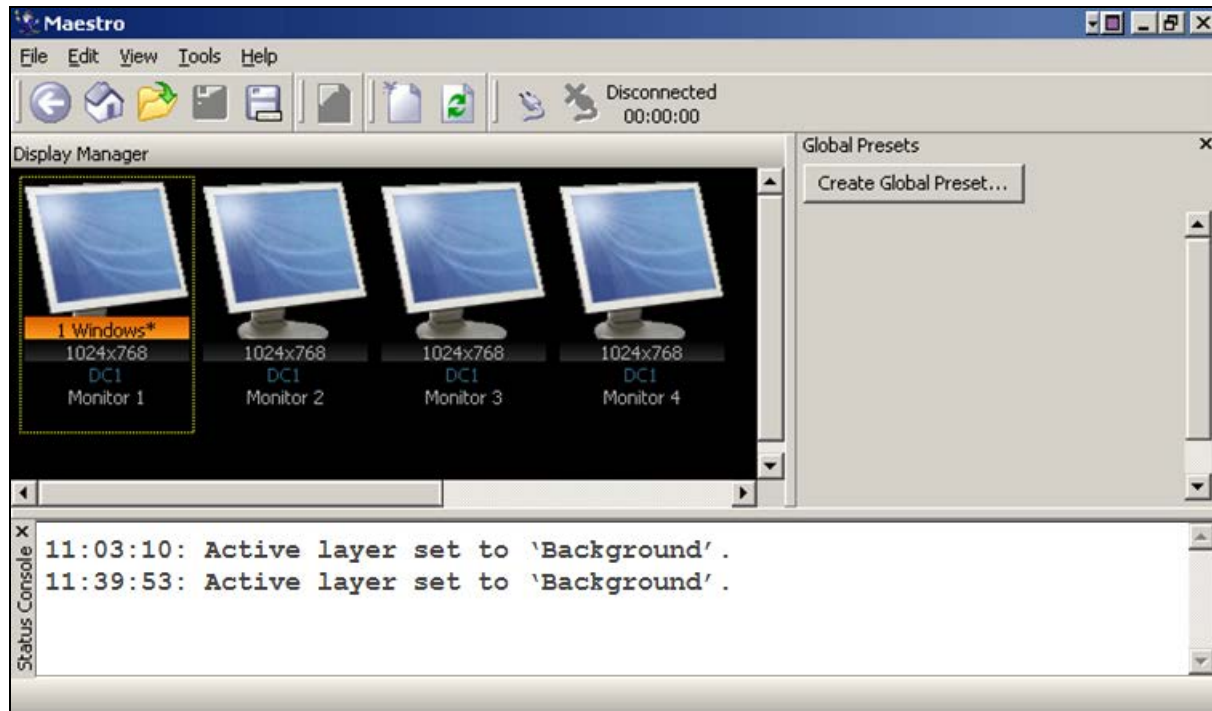

Figure 12-8: Display Manager

5. Select the window (video input) that will be used for Closed Captioning Decode.
6. Click on the **Properties** box.
7. Expand the **Appearance** heading.
8. Locate **Auxiliary OSD**, and click the check box to select (enable).

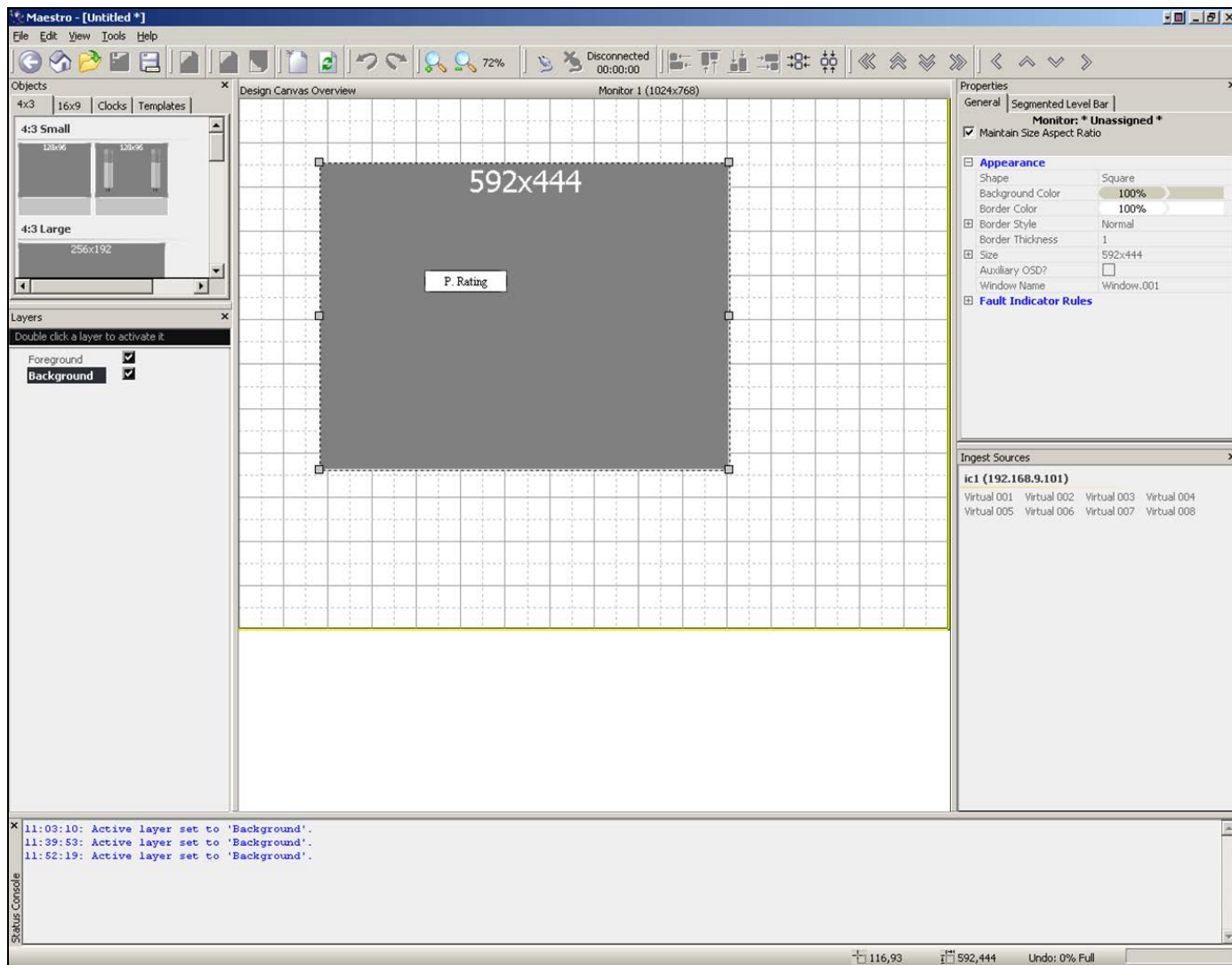

Figure 12-9: Properties > Appearance

If closed captioning is present on the video source, then the closed captioning should now appear on the output of the MVP for the configured video source. If closed captioning / teletext is not decoded, verify the line number/page number and configure accordingly using VistaLINK® PRO.

This page left intentionally blank

13. CONFIGURING FONTS

The MVP installer comes with a selection of predefined fonts. If installed to the default location, these fonts can be found at:

C:\Program Files\Evertz\MVP\Resources\Fonts

To configure fonts on the MVP:

- Using the System Manager, click the **Configure Fonts** button.



- In the window that appears, click on the browse button, and then navigate to the save location for fonts.

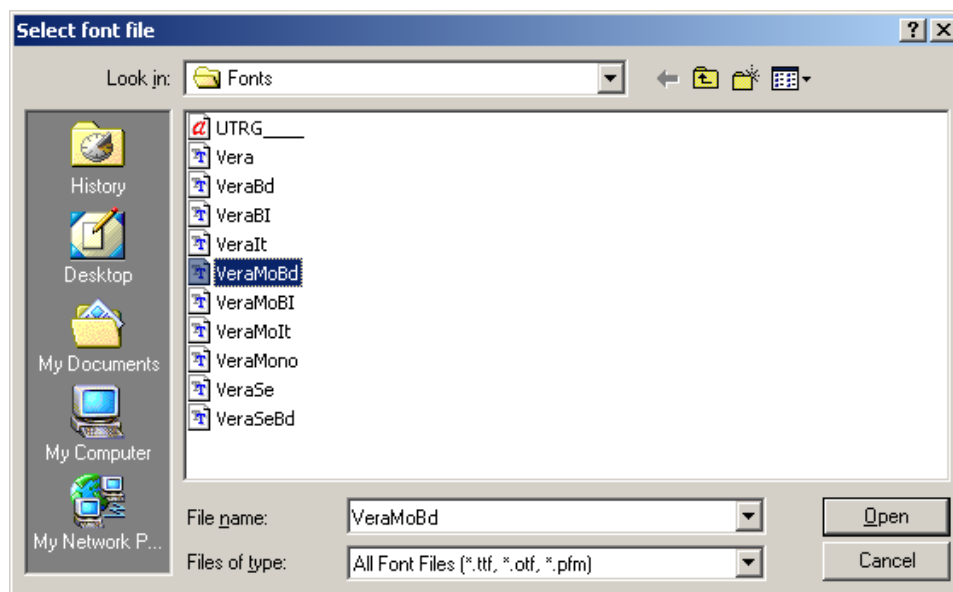

- When finished, you will send the fonts to the appropriate card.

To send the fonts to a specific card, select the card in the Font Configuration window, and then click the **Send Fonts to Selected Cards** button.

To send the fonts to all cards, do not select any card, and then click the **Send Fonts to All Cards** button.

- Reboot the display card.
- Open Maestro, and right click on the system. From the menu that appears, choose **Download System Configuration**.

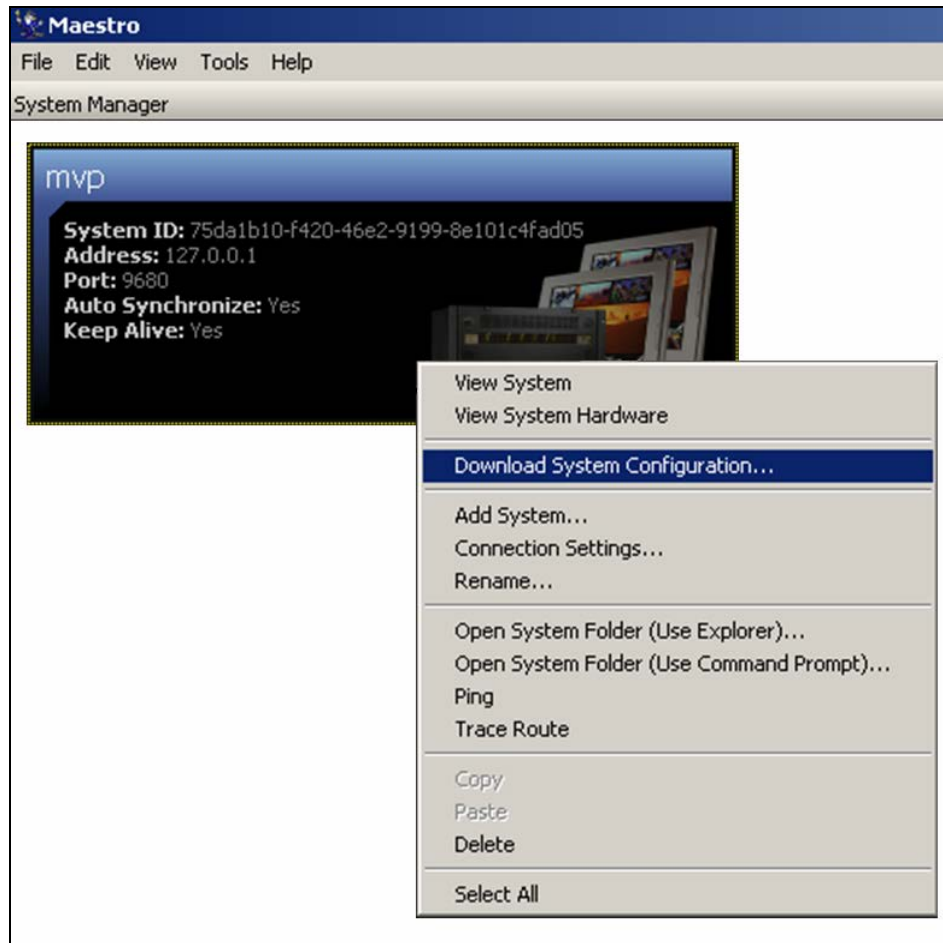

The fonts have now been successfully configured.